







OE

DAIHATSU

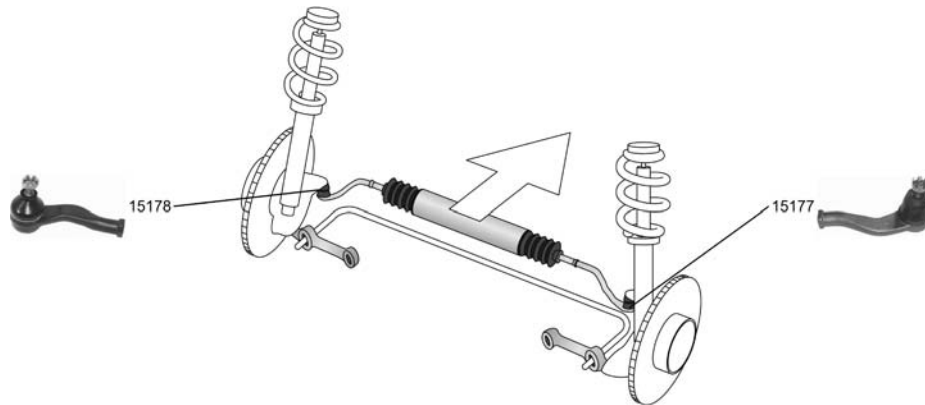
APPLAUSE I (A101, A111)

06.89 - 07.97





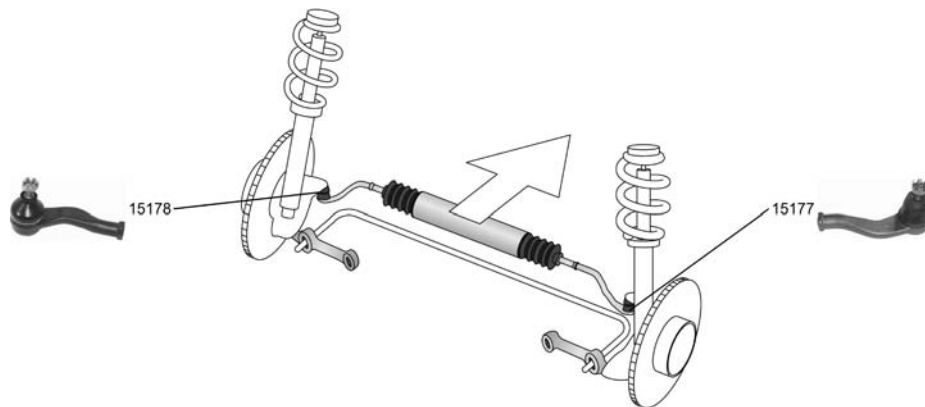

<p>Spurstangenkopf / Tie-rod End Gewindeart: mit Rechtsgewinde / Thread Type: with right-hand thread Gewindemaß / Thread Size:M14x1,5</p>		<p>15177 45046-87784</p> 
<p>1.6 16V (A101), 66 kW 06.89 - 07.97 1.6 16V (A101), 77 kW 06.89 - 07.97 1.6 16V 4WD (A111) 06.89 - 07.97</p>		
<p>Spurstangenkopf / Tie-rod End Gewindeart: mit Linksgewinde / Thread Type: With left-hand thread Gewindemaß / Thread Size:M14x1,5</p>		<p>15178 45047-87784</p> 
<p>1.6 16V (A101), 66 kW 06.89 - 07.97 1.6 16V (A101), 77 kW 06.89 - 07.97 1.6 16V 4WD (A111) 06.89 - 07.97</p>		

APPLAUSE II

07.97 -



<p>Spurstangenkopf / Tie-rod End Gewindeart: mit Rechtsgewinde / Thread Type: with right-hand thread Gewindemaß / Thread Size:M14x1,5</p>		<p>15177 45046-87784</p> 
<p>ALL TYPES</p>		
<p>Spurstangenkopf / Tie-rod End Gewindeart: mit Linksgewinde / Thread Type: With left-hand thread Gewindemaß / Thread Size:M14x1,5</p>		<p>15178 45047-87784</p> 
<p>ALL TYPES</p>		









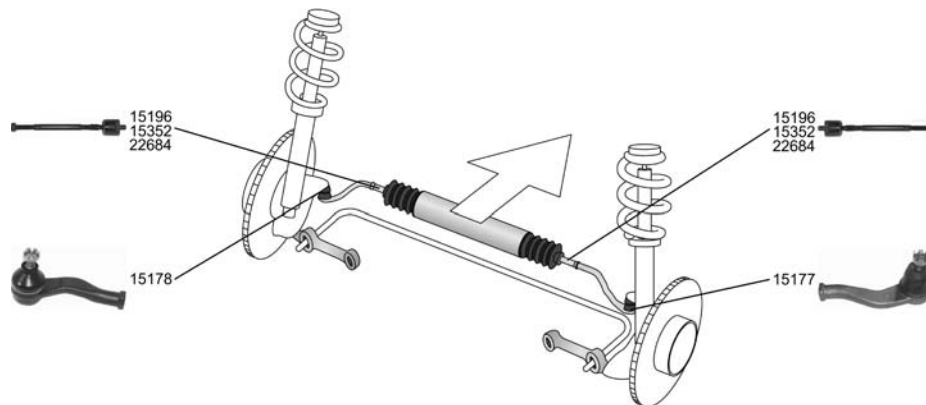





DAIHATSU

CHARADE III (G100, G101, G102)

01.87 - 01.93



<p>Spurstangenkopf / Tie-rod End Gewindeart: mit Rechtsgewinde / Thread Type: with right-hand thread Gewindemaß / Thread Size:M14x1,5</p> <p>ALL TYPES ausser/except for : 1.3 16V (G102) 09.88 - 02.93</p>		<p>15177 45046-87784</p> 
<p>Spurstangenkopf / Tie-rod End Gewindeart: mit Linksgewinde / Thread Type: With left-hand thread Gewindemaß / Thread Size:M14x1,5</p> <p>ALL TYPES ausser/except for : 1.3 16V (G102) 09.88 - 02.93</p>		<p>15178 45047-87784</p> 
<p>Axialgelenk, Spurstange / Axial Rod, tie rod</p> <p>1.0 (G100), 38 kW 03.87 - 12.92 1.0 (G100), 41 kW 04.89 - 12.92 1.0 GTi (G100) 03.87 - 12.92 1.3 i (G102) 06.88 - 12.92 1.0 D (G101) 03.87 - 12.92 1.0 TD (G101) 03.87 - 12.92 1.0 (G100), 40 kW 11.90 - 12.92</p>	 <p>01.1990-></p>	<p>15196 45503-87709</p> 
<p>Axialgelenk, Spurstange / Axial Rod, tie rod Gewindeart: mit Rechtsgewinde / Thread Type: with right-hand thread Gewindemaß / Thread Size:M12x1,5</p> <p>1.0 Turbo (G100) 03.87 - 10.90 1.3 i 4WD (G102) 06.88 - 01.93 1.0 (G100), 38 kW 03.87 - 12.92</p> <p>1.0 (G100), 41 kW 04.89 - 12.92</p> <p>1.0 (G100), 41 kW 04.89 - 12.92</p>	 <p> ->12.1989</p> <p> ->12.1989</p> <p>RHD ->12.1989</p>	<p>15352 45503-87705</p> 
<p>Axialgelenk, Spurstange / Axial Rod, tie rod</p> <p>1.0 (G100), 38 kW 03.87 - 12.92 1.0 (G100), 40 kW 11.90 - 12.92 1.0 Turbo (G100) 03.87 - 10.90 1.0 GTi (G100) 03.87 - 12.92 1.3 i (G102) 06.88 - 12.92 1.3 i 4WD (G102) 06.88 - 01.93 1.0 D (G101) 03.87 - 12.92 1.0 TD (G101) 03.87 - 12.92 1.0 (G100), 41 kW 04.89 - 12.92</p>	 <p>08.1989-></p>	<p>22684 45503-87711</p> 







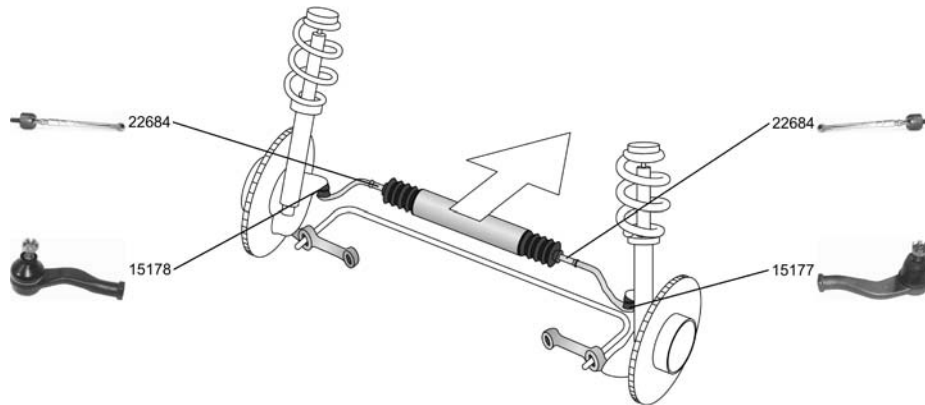

OE

DAIHATSU

CHARADE IV (G200, G202)

01.93 - 03.96





<p>Spurstangenkopf / Tie-rod End Gewindeart: mit Rechtsgewinde / Thread Type: with right-hand thread Gewindemaß / Thread Size:M14x1,5</p> <p>ALL TYPES ausser/except for :</p> <table border="1"> <tr> <td>1.0</td> <td>09.94 - 03.96</td> </tr> <tr> <td>1.5 (G203)</td> <td>01.96 -</td> </tr> </table>	1.0	09.94 - 03.96	1.5 (G203)	01.96 -		<p>15177 45046-87784</p> 
1.0	09.94 - 03.96					
1.5 (G203)	01.96 -					
<p>Spurstangenkopf / Tie-rod End Gewindeart: mit Linksgewinde / Thread Type: With left-hand thread Gewindemaß / Thread Size:M14x1,5</p> <p>ALL TYPES ausser/except for :</p> <table border="1"> <tr> <td>1.0</td> <td>09.94 - 03.96</td> </tr> <tr> <td>1.5 (G203)</td> <td>01.96 -</td> </tr> </table>	1.0	09.94 - 03.96	1.5 (G203)	01.96 -		<p>15178 45047-87784</p> 
1.0	09.94 - 03.96					
1.5 (G203)	01.96 -					
<p>Axialgelenk, Spurstange / Axial Rod, tie rod</p> <p>ALL TYPES ausser/except for :</p> <table border="1"> <tr> <td>1.0</td> <td>09.94 - 03.96</td> </tr> <tr> <td>1.5 (G203)</td> <td>01.96 -</td> </tr> </table>	1.0	09.94 - 03.96	1.5 (G203)	01.96 -		<p>22684 45503-87711</p> 
1.0	09.94 - 03.96					
1.5 (G203)	01.96 -					

CHARADE IV Stufenheck/Saloon/avec coffre (G203)

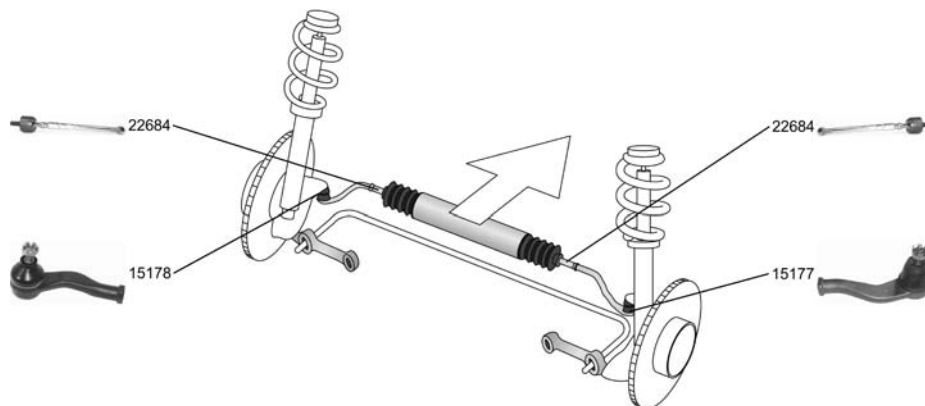
08.94 -







<p>Spurstangenkopf / Tie-rod End Gewindeart: mit Rechtsgewinde / Thread Type: with right-hand thread Gewindemaß / Thread Size:M14x1,5</p>		<p>15177 45046-87784</p> 
<p>ALL TYPES</p>		



DAIHATSU







CHARADE IV
Stufenheck/Saloon/avec coffre
(G203)

08.94 -

 Spurstangenkopf / Tie-rod End Gewindeart: mit Linksgewinde / Thread Type: With left-hand thread Gewindemaß / Thread Size:M14x1,5		15178 45047-87784 
ALL TYPES		
Axialgelenk, Spurstange / Axial Rod, tie rod ALL TYPES		22684 45503-87711 

CHARMANT (A)





10.81 - 07.87

 Spurstangenkopf / Tie-rod End Gewindeart: mit Linksgewinde / Thread Type: With left-hand thread Gewindemaß / Thread Size:M14x1,5		15719 45046-29155 
1.3 (A35) 11.81 - 07.87		
Axialgelenk, Spurstange / Axial Rod, tie rod Gewindeart: mit Rechtsgewinde / Thread Type: with right-hand thread Gewindemaß / Thread Size:M14x1,5		11913 45503-19045 
1.3 (A35) 11.81 - 07.87 1.6 (A60) 08.83 - 07.87		
Trag-/Führungsgelenk / Support-/ Steering Link 1.3 (A35) 11.81 - 07.87 1.6 (A60) 08.83 - 07.87		11894 43308-19035 

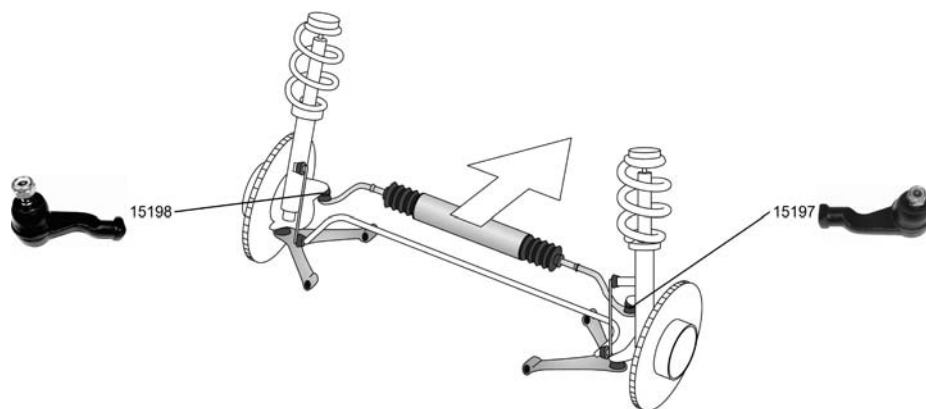
CUORE II (L80, L81)

09.85 - 12.90



Spurstangenkopf / Tie-rod End Gewindeart: mit Rechtsgewinde / Thread Type: with right-hand thread Gewindemaß / Thread Size:M12x1,25 ALL TYPES		15197 45046-87780 
Spurstangenkopf / Tie-rod End Gewindeart: mit Rechtsgewinde / Thread Type: with right-hand thread Gewindemaß / Thread Size:M12x1,25 ALL TYPES		15198 45047-87780 





OE

DAIHATSU

CUORE III (L201)

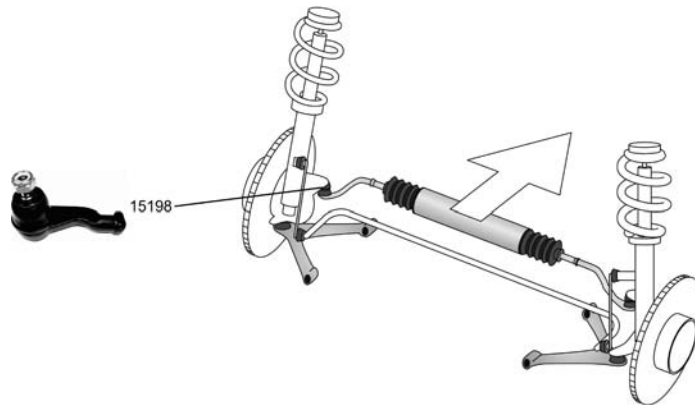
08.90 - 12.94





<p>Spurstangenkopf / Tie-rod End Gewindeart: mit Rechtsgewinde / Thread Type: with right-hand thread Gewindemaß / Thread Size: M12x1,25</p>		<p>15198 45047-87780</p> 
<p>ALL TYPES</p>		

CUORE IV (L501)

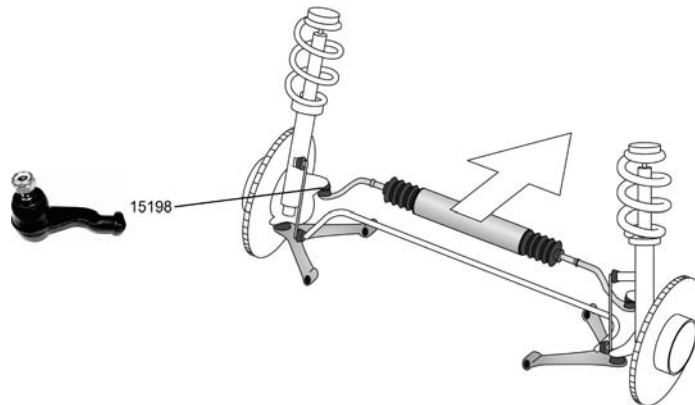
01.95 - 11.96



<p>Spurstangenkopf / Tie-rod End Gewindeart: mit Rechtsgewinde / Thread Type: with right-hand thread Gewindemaß / Thread Size: M12x1,25</p>		<p>15198 45047-87780</p> 
<p>ALL TYPES</p>		





DAIHATSU

MOVE (L6, L9)

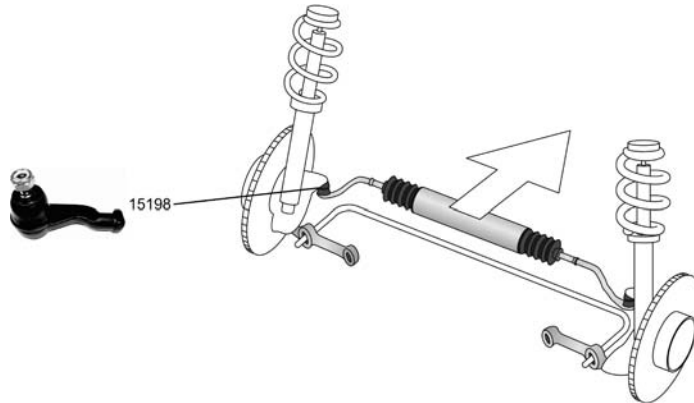
10.96 -





<p>Spurstangenkopf / Tie-rod End Gewindeart: mit Rechtsgewinde / Thread Type: with right-hand thread Gewindemaß / Thread Size:M12x1,25</p>		<p>15198 45047-87780</p> 
<p>ALL TYPES</p>		

ROCKY Hard Top (F7, F8)

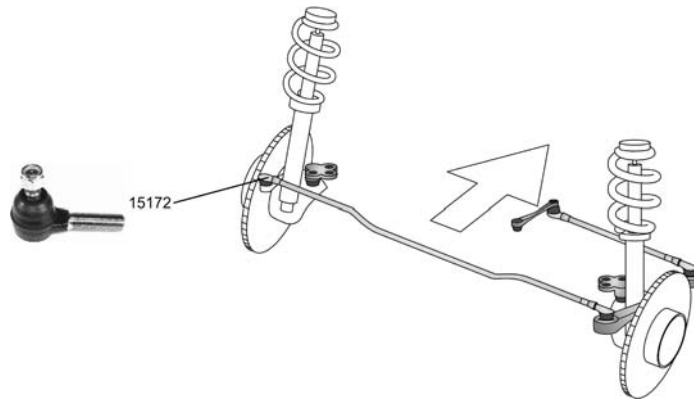
02.85 - 04.93



<p>Spurstangenkopf / Tie-rod End Gewindeart: mit Linksgewinde / Thread Type: With left-hand thread Gewindemaß / Thread Size:M20x1,5</p>		<p>15172 45047-87380</p> 								
<table border="0"> <tr> <td>2.0</td> <td>02.85 - 04.93</td> </tr> <tr> <td>2.8 TD, 67 kW</td> <td>12.87 - 04.93</td> </tr> <tr> <td>2.8 D</td> <td>02.85 -</td> </tr> <tr> <td>2.8 TD, 75 kW</td> <td>09.91 -</td> </tr> </table>	2.0	02.85 - 04.93	2.8 TD, 67 kW	12.87 - 04.93	2.8 D	02.85 -	2.8 TD, 75 kW	09.91 -	<p>RHD ->09.1989</p>	
2.0	02.85 - 04.93									
2.8 TD, 67 kW	12.87 - 04.93									
2.8 D	02.85 -									
2.8 TD, 75 kW	09.91 -									

Arithmetische Liste / Part number list

Artikelnummer Article No.	Seite Page	Hersteller Manufacturer	Artikelnummer Article No.	Seite Page	Hersteller Manufacturer
11894	4	DAIHATSU			
Trag-/Führungsgelenk / Support-/ Steering Link					
11913	4	DAIHATSU			
Axialgelenk, Spurstange / Axial Rod, tie rod					
15172	6 7	DAIHATSU			
Spurstangenkopf / Tie-rod End					
15177	1 2 3	DAIHATSU			
Spurstangenkopf / Tie-rod End					
15178	1 2 3	DAIHATSU			
Spurstangenkopf / Tie-rod End	4				
15196	2	DAIHATSU			
Axialgelenk, Spurstange / Axial Rod, tie rod					
15197	4	DAIHATSU			
Spurstangenkopf / Tie-rod End					
15198	4 5 6	DAIHATSU			
Spurstangenkopf / Tie-rod End					
15352	2	DAIHATSU			
Axialgelenk, Spurstange / Axial Rod, tie rod					
15719	4	DAIHATSU			
Spurstangenkopf / Tie-rod End					
22684	2 3 4	DAIHATSU			
Axialgelenk, Spurstange / Axial Rod, tie rod					

Vergleichsliste / Cross reference list

Vergleichs-Nr. Compare No.	Artikelnummer Article No.	Vergleichs-Nr. Compare No.	Artikelnummer Article No.	Vergleichs-Nr. Compare No.	Artikelnummer Article No.
DAIHATSU					
43308-19035	11894				
45046-29155	15719				
45046-87780	15197				
45046-87784	15177				
45047-87380	15172				
45047-87780	15198				
45047-87784	15178				
45503-19045	11913				
45503-87705	15352				
45503-87709	15196				
45503-87711	22684				

Neuaufnahmen / New to range

Artikelnummer Article No.	Seite Page	Hersteller Manufacturer	Artikelnummer Article No.	Seite Page	Hersteller Manufacturer
11894	4	DAIHATSU			
11913	4	DAIHATSU			
15172	6 7	DAIHATSU			
15178	1 2 3 4	DAIHATSU			
15197	4	DAIHATSU			
15719	4	DAIHATSU			
22684	2 3 4	DAIHATSU			

Geänderte Bestellnummer / Amended part numbers

Artikelnummer alt Article No. old	Artikelnummer neu Article No. new	Artikelnummer alt Article No. old	Artikelnummer neu Article No. new	Artikelnummer alt Article No. old	Artikelnummer neu Article No. new

Geänderte Bestellnummer / Amended part numbers

Artikelnummer neu Article No. new	Artikelnummer alt Article No. old	Artikelnummer neu Article No. new	Artikelnummer alt Article No. old	Artikelnummer neu Article No. new	Artikelnummer alt Article No. old