











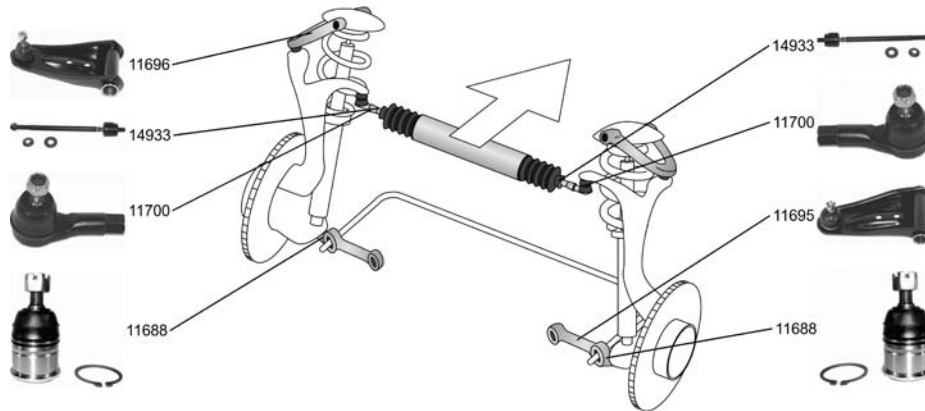



OE

HONDA

ACCORD III (CA4, CA5)

11.85 - 12.89



<p>Spurstangenkopf / Tie-rod End Innengewinde [mm] / Inner Thread [mm]:M12x1,25 Gewindeart: mit Rechtsgewinde / Thread Type: with right-hand thread ALL TYPES ausser/except for : 1.6 L (CA5) 11.85 - 12.89</p>		<p>11700 53540-SC2-004</p> 
<p>Axialgelenk, Spurstange / Axial Rod, tie rod Gewindeart: mit Rechtsgewinde / Thread Type: with right-hand thread Gewindemaß / Thread Size:M12x1,25 ALL TYPES ausser/except for : 1.6 L (CA5) 11.85 - 12.89</p>		<p>14933 53521-SE0-951</p> 
<p>Lenker, Radaufhängung / Track Control Arm ALL TYPES ausser/except for : 1.6 L (CA5) 11.85 - 12.89</p>		<p>11695 51459-SE0-003</p> 
<p>Lenker, Radaufhängung / Track Control Arm ALL TYPES ausser/except for : 1.6 L (CA5) 11.85 - 12.89</p>		<p>11696 51469-SE0-003</p> 
<p>Trag-/Führungsgelenk / Support-/ Steering Link ALL TYPES ausser/except for : 1.6 L (CA5) 11.85 - 12.89</p>		<p>11688 51220-SK7-013</p> 
<p>Faltenbalgsatz, Lenkung / Bellow Kit, steering system ALL TYPES ausser/except for : 1.6 L (CA5) 11.85 - 12.89 2.0 i 16V (CA5) 01.87 - 12.89</p>		<p>30139 53534-SB4-951</p> 
<p> Lenker, Radaufhängung / Track Control Arm ALL TYPES ausser/except for : 1.6 L (CA5) 11.85 - 12.89</p>		<p>11697 52390-SE0-043</p> 



HONDA

ACCORD III Aerodeck/Estate/Break (CA5)

11.85 - 12.89

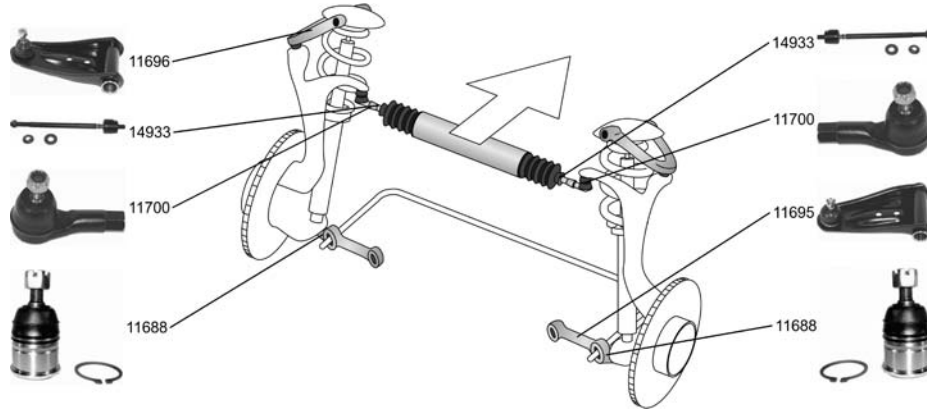

<p>Spurstangenkopf / Tie-rod End Innengewinde [mm] / Inner Thread [mm]:M12x1,25 Gewindeart: mit Rechtsgewinde / Thread Type: with right-hand thread</p>		<p>11700 53540-SC2-004</p> 
<p>ALL TYPES</p>		
<p>Axialgelenk, Spurstange / Axial Rod, tie rod Gewindeart: mit Rechtsgewinde / Thread Type: with right-hand thread Gewindemaß / Thread Size:M12x1,25</p>		<p>14933 53521-SE0-951</p> 
<p>ALL TYPES</p>		
<p>Lenker, Radaufhängung / Track Control Arm</p>		<p>11695 51459-SE0-003</p> 
<p>ALL TYPES</p>		
<p>Lenker, Radaufhängung / Track Control Arm</p>		<p>11696 51469-SE0-003</p> 
<p>ALL TYPES</p>		
<p>Trag-/Führungsgelenk / Support-/ Steering Link</p>		<p>11688 51220-SK7-013</p> 
<p>ALL TYPES</p>		
<p>Faltenbalsatz, Lenkung / Bellow Kit, steering system</p>		<p>30139 53534-SB4-951</p> 
<p>2.0 EX 10.87 - 12.89</p>		
<p>2.0 EX (CA5) 11.85 - 12.89</p>		
<p>2.0 EXi (CA5) 11.85 - 12.89</p>		
<p>1.6 L (CA4) 11.85 - 12.89</p>		
<p>Lenker, Radaufhängung / Track Control Arm</p>		<p>11697 52390-SE0-043</p> 
<p>ALL TYPES</p>		











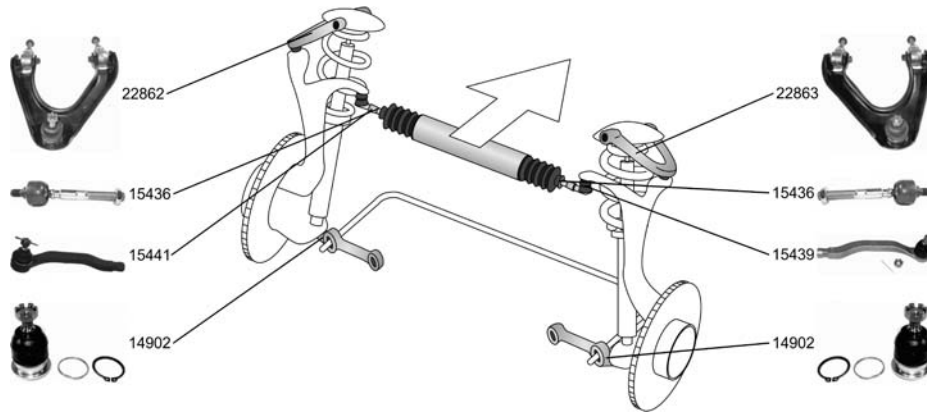









OE

HONDA

ACCORD IV (CB3, CB7)

01.90 - 03.93



<p>Spurstangenkopf / Tie-rod End Gewindeart: mit Rechtsgewinde / Thread Type: with right-hand thread</p> <p>ALL TYPES ausser/except for :</p> <p>1.8 (CB 1) 01.90 - 03.93</p> <p>2.2 i 16V (CB7) 01.90 - 03.93</p>		<p>15439 53540-SM4-004</p> 
<p>Spurstangenkopf / Tie-rod End Gewindeart: mit Rechtsgewinde / Thread Type: with right-hand thread</p> <p>ALL TYPES ausser/except for :</p> <p>1.8 (CB 1) 01.90 - 03.93</p> <p>2.2 i 16V (CB7) 01.90 - 03.93</p>		<p>15441 53560-SM4-004</p> 
<p>Axialgelenk, Spurstange / Axial Rod, tie rod</p> <p>ALL TYPES ausser/except for :</p> <p>1.8 (CB 1) 01.90 - 03.93</p> <p>2.2 i 16V (CB7) 01.90 - 03.93</p>		<p>15436 53521-SM4-013</p> 
<p>Lenker, Radaufhängung / Track Control Arm</p> <p>2.0 16V (CB3), 66 kW 01.90 - 03.93</p> <p>2.0 i 16V (CB3) 01.90 - 03.93</p> <p>2.2 i 16V Automatik (CB7) 01.90 - 03.93</p> <p>2.2 i 16V (CB7) 01.90 - 03.93</p>		<p>22862 51460-SM1-A03</p> 
<p>Lenker, Radaufhängung / Track Control Arm</p> <p>2.0 16V (CB3), 81 kW 01.90 - 03.93</p> <p>2.0 i 16V (CB3) 01.90 - 03.93</p> <p>2.2 i 16V Automatik (CB7) 01.90 - 03.93</p> <p>2.2 i 16V (CB7) 01.90 - 03.93</p>		<p>22863 51450-SM1-A03</p> 
<p>Trag-/Führungsgelenk / Support-/ Steering Link</p> <p>ALL TYPES ausser/except for :</p> <p>1.8 (CB 1) 01.90 - 03.93</p> <p>2.2 i 16V (CB7) 01.90 - 03.93</p>		<p>14902 51220-S84-A02</p> 
<p>Faltenbalgsatz, Lenkung / Bellow Kit, steering system</p> <p>2.0 16V (CB3) 01.90 - 03.93</p> <p>2.0 i 16V (CB3) 01.90 - 03.93</p>	 	<p>30139 53534-SB4-951</p> 
<p>Faltenbalgsatz, Lenkung / Bellow Kit, steering system</p> <p>2.2 i 16V Automatik (CB7) 01.90 - 03.93</p> <p>2.2 i 16V (CB7) 01.90 - 03.93</p>	 	<p>30147 53534-SV4-N01</p> 









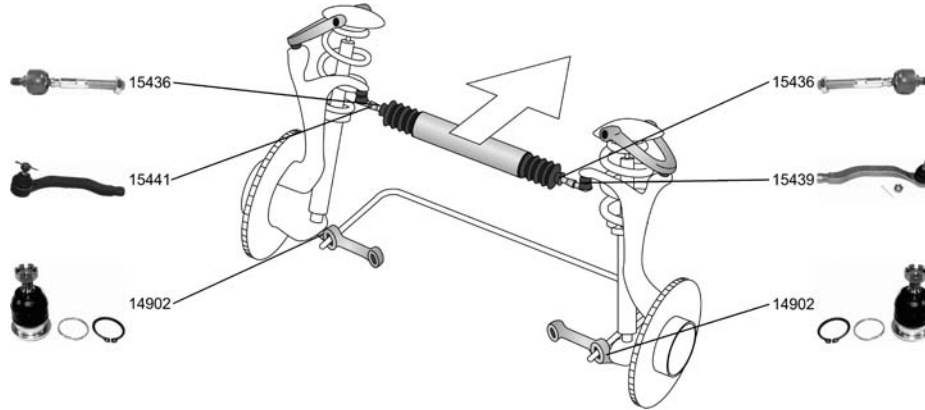



HONDA

ACCORD IV Aerodeck/Estate/Break
(CB8, CC)

01.91 - 09.93



<p>Spurstangenkopf / Tie-rod End Gewindeart: mit Rechtsgewinde / Thread Type: with right-hand thread</p> <p>2.0 i 16V (CC9) 03.93 - 12.93 2.2 i 16V (CB8) 01.91 - 12.93</p>		<p>15439 53540-SM4-004</p> 
<p>Spurstangenkopf / Tie-rod End Gewindeart: mit Rechtsgewinde / Thread Type: with right-hand thread</p> <p>2.0 i 16V (CC9) 03.93 - 12.93 2.2 i 16V (CB8) 01.91 - 12.93</p>		<p>15441 53560-SM4-004</p> 
<p>Axialgelenk, Spurstange / Axial Rod, tie rod</p> <p>2.0 i 16V (CC9) 03.93 - 12.93 2.2 i 16V (CB8) 01.91 - 12.93</p>		<p>15436 53521-SM4-013</p> 
<p>Trag-/Führungsgelenk / Support- / Steering Link</p> <p>2.0 i 16V (CC9) 03.93 - 12.93 2.2 i 16V (CB8) 01.91 - 12.93</p>		<p>14902 51220-S84-A02</p> 
<p>Faltenbalgsatz, Lenkung / Bellow Kit, steering system</p> <p>2.0 i 16V (CC9) 03.93 - 12.93 2.2 i 16V (CB8) 01.91 - 12.93</p>	 	<p>30147 53534-SV4-N01</p> 











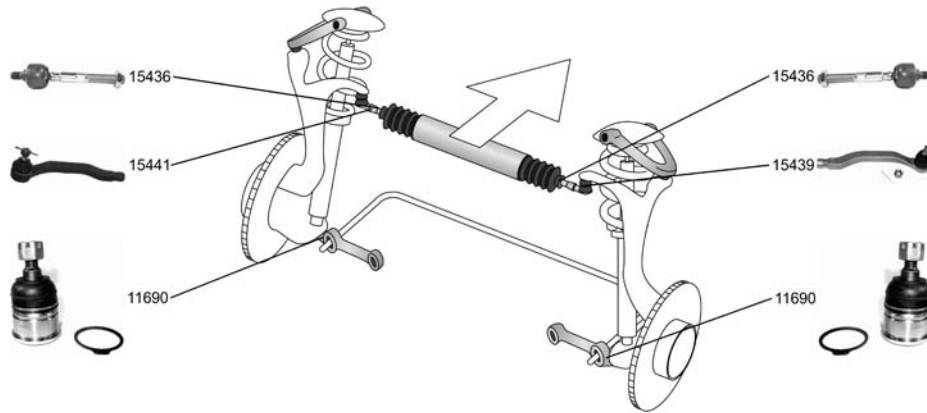



OE

HONDA

ACCORD IV Coupe (CC1)

01.92 - 09.93



<p>Spurstangenkopf / Tie-rod End Gewindeart: mit Rechtsgewinde / Thread Type: with right-hand thread ALL TYPES</p>		<p>15439 53540-SM4-004</p> 
<p>Spurstangenkopf / Tie-rod End Gewindeart: mit Rechtsgewinde / Thread Type: with right-hand thread ALL TYPES</p>		<p>15441 53560-SM4-004</p> 
<p>Axialgelenk, Spurstange / Axial Rod, tie rod ALL TYPES</p>		<p>15436 53521-SM4-013</p> 
<p>Trag-/Führungsgelenk / Support-/ Steering Link ALL TYPES</p>		<p>11690 51220-SM4-013</p> 
<p>Faltenbalgsatz, Lenkung / Bellow Kit, steering system ALL TYPES</p>	 	<p>30139 53534-SB4-951</p> 









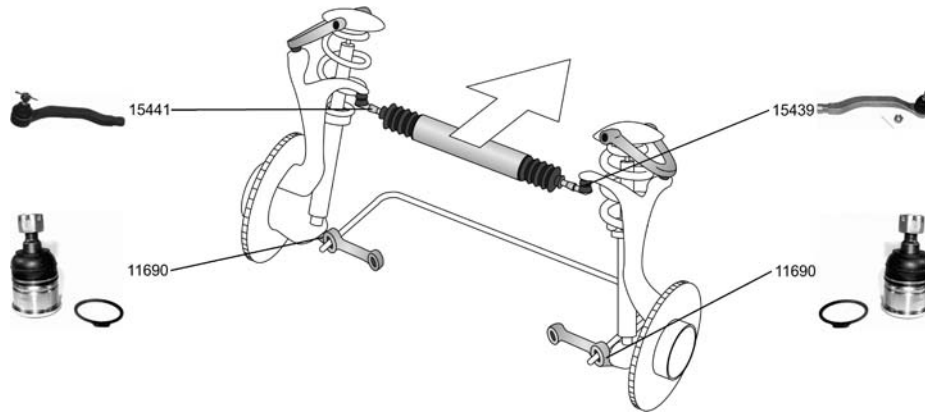

HONDA

ACCORD V (CC7)

03.93 - 02.96





Spurstangenkopf / Tie-rod End Gewindeart: mit Rechtsgewinde / Thread Type: with right-hand thread 2.0 i 03.93 - 01.96 2.0 i S 03.93 - 01.96 2.3 i SR 03.93 - 01.96		15439 53540-SM4-004 
Spurstangenkopf / Tie-rod End Gewindeart: mit Rechtsgewinde / Thread Type: with right-hand thread 2.0 i 03.93 - 01.96 2.0 i S 03.93 - 01.96 2.3 i SR 03.93 - 01.96		15441 53560-SM4-004 
Trag-/Führungsgelenk / Support-/ Steering Link 2.0 i 03.93 - 01.96 2.0 i S 03.93 - 01.96 2.3 i SR 03.93 - 01.96		11690 51220-SM4-013 
Faltenbalgsatz, Lenkung / Bellow Kit, steering system 2.0 i 03.93 - 01.96 2.0 i S 03.93 - 01.96 2.3 i SR 03.93 - 01.96	 	30147 53534-SV4-N01 

ACCORD V Aerodeck/Estate/Break (CE)

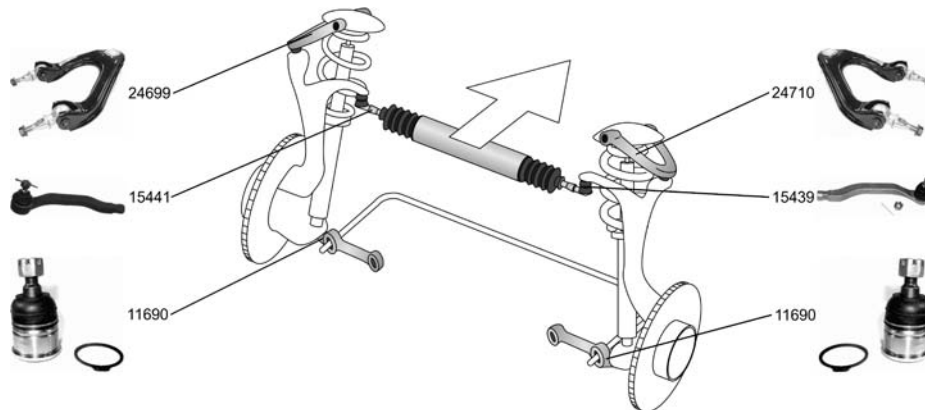
09.93 - 02.98



Spurstangenkopf / Tie-rod End Gewindeart: mit Rechtsgewinde / Thread Type: with right-hand thread ALL TYPES		15439 53540-SM4-004 
--	---	---















OE

HONDA

ACCORD V Aerodeck/Estate/Break (CE)



09.93 - 02.98

 Spurstangenkopf / Tie-rod End Gewindeart: mit Rechtsgewinde / Thread Type: with right-hand thread ALL TYPES		15441 53560-SM4-004 
Lenker, Radaufhängung / Track Control Arm ALL TYPES		24699 51460-SV4-000 
Lenker, Radaufhängung / Track Control Arm ALL TYPES		24710 51450-SV4-000 
Trag-/Führungsgelenk / Support-/ Steering Link ALL TYPES		11690 51220-SM4-013 
Faltenbalsatz, Lenkung / Bellow Kit, steering system 2.0 i LS 16V (CE2) 09.93 - 02.98		30147 53534-SV4-N01 
Faltenbalsatz, Lenkung / Bellow Kit, steering system 2.2 i ES (CE1) 09.93 - 02.98		30234 53534-S84-A01 

ACCORD V Coupe (CD7, CD9)

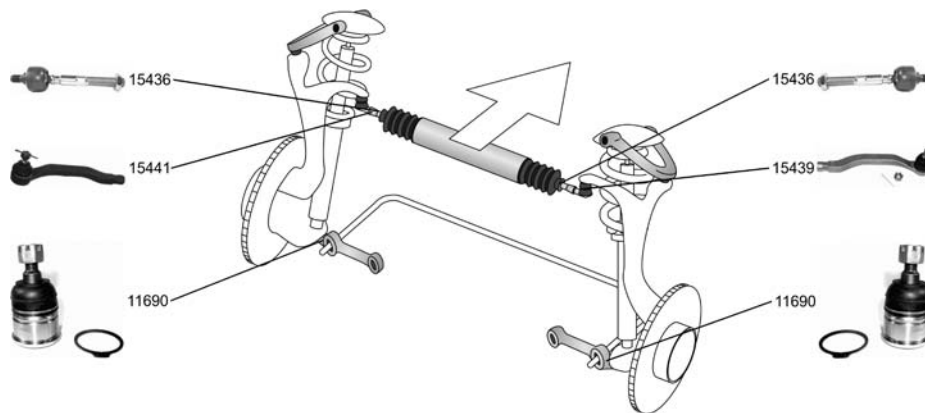
09.93 - 02.98











Spurstangenkopf / Tie-rod End Gewindeart: mit Rechtsgewinde / Thread Type: with right-hand thread 2.2 i ES 09.93 - 02.98		15439 53540-SM4-004 
--	---	--



HONDA

ACCORD V Coupe (CD7, CD9)





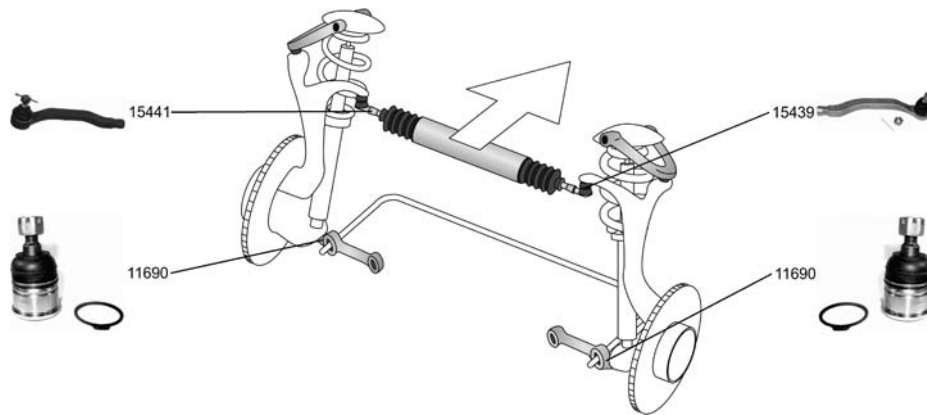

09.93 - 02.98

 Spurstangenkopf / Tie-rod End Gewindeart: mit Rechtsgewinde / Thread Type: with right-hand thread 2.2 i ES 09.93 - 02.98		15441 53560-SM4-004 
Axialgelenk, Spurstange / Axial Rod, tie rod 2.2 i ES 09.93 - 02.98		15436 53521-SM4-013 
Trag-/Führungsgelenk / Support-/ Steering Link 2.2 i ES 09.93 - 02.98		11690 51220-SM4-013 
Faltenbalsatz, Lenkung / Bellow Kit, steering system 2.0 (DC9) 09.93 - 12.97 2.2 i ES 09.93 - 02.98		30234 53534-S84-A01 

ACCORD VI (CE, CF)

02.96 - 10.98



Spurstangenkopf / Tie-rod End Gewindeart: mit Rechtsgewinde / Thread Type: with right-hand thread ALL TYPES		15439 53540-SM4-004 
Spurstangenkopf / Tie-rod End Gewindeart: mit Rechtsgewinde / Thread Type: with right-hand thread ALL TYPES		15441 53560-SM4-004 
Trag-/Führungsgelenk / Support-/ Steering Link ALL TYPES		11690 51220-SM4-013 











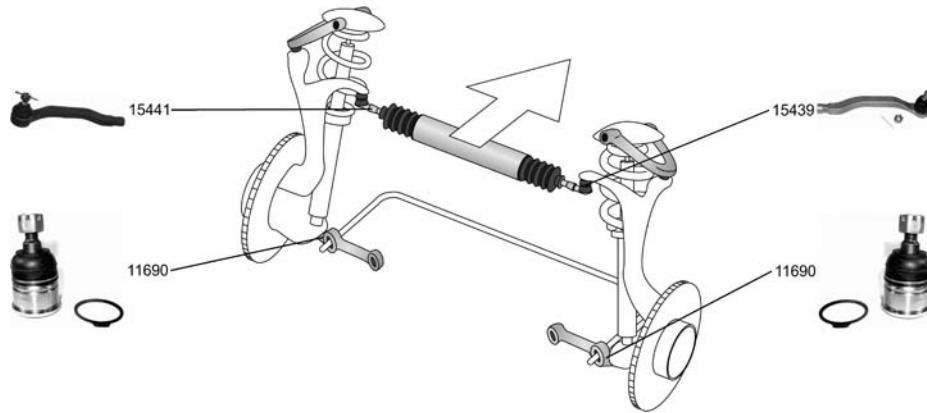

OE

HONDA

ACCORD VII (CG)

10.98 -



<p>Spurstangenkopf / Tie-rod End Gewindeart: mit Rechtsgewinde / Thread Type: with right-hand thread ALL TYPES</p>		<p>15439 53540-SM4-004</p> 
<p>Spurstangenkopf / Tie-rod End Gewindeart: mit Rechtsgewinde / Thread Type: with right-hand thread ALL TYPES</p>		<p>15441 53560-SM4-004</p> 
<p>Trag-/Führungsgelenk / Support-/ Steering Link ALL TYPES</p>		<p>11690 51220-SM4-013</p> 
<p>Stange/Strebe, Stabilisator / Rod/Strut, stabiliser Pendelstange / Suspension Rod ALL TYPES</p>		<p>29795 51321-S84-A01</p>
<p>Stange/Strebe, Stabilisator / Rod/Strut, stabiliser Pendelstange / Suspension Rod ALL TYPES</p>		<p>29796 51320-S84-A01</p>
<p>Faltenbalgsatz, Lenkung / Bellow Kit, steering system ALL TYPES</p>		<p>30221 53536-S1A-E01</p> 









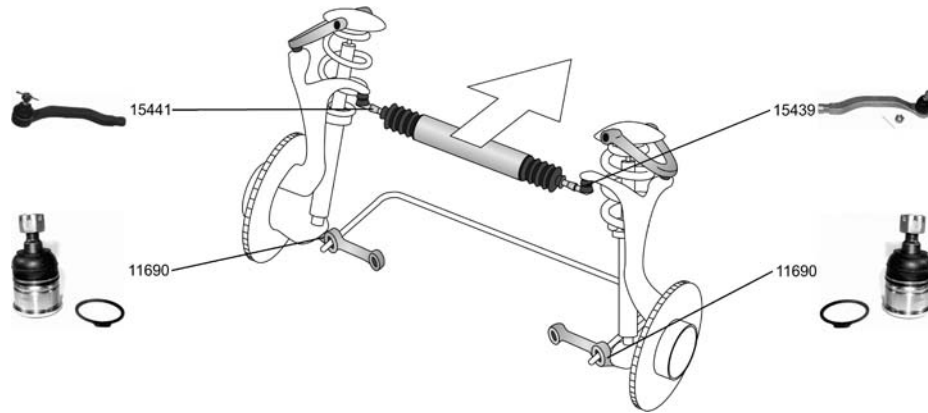



HONDA

ACCORD VII Aerodeck/Estate/Break

02.98 -



<p>Spurstangenkopf / Tie-rod End Gewindeart: mit Rechtsgewinde / Thread Type: with right-hand thread ALL TYPES</p>		<p>15439 53540-SM4-004</p> 
<p>Spurstangenkopf / Tie-rod End Gewindeart: mit Rechtsgewinde / Thread Type: with right-hand thread ALL TYPES</p>		<p>15441 53560-SM4-004</p> 
<p>Trag-/Führungsgelenk / Support-/ Steering Link ALL TYPES</p>		<p>11690 51220-SM4-013</p> 
<p>Stange/Strebe, Stabilisator / Rod/Strut, stabiliser Pendelstange / Suspension Rod ALL TYPES</p>		<p>29795 51321-S84-A01</p>
<p>Stange/Strebe, Stabilisator / Rod/Strut, stabiliser Pendelstange / Suspension Rod ALL TYPES</p>		<p>29796 51320-S84-A01</p>
<p>Faltenbalgsatz, Lenkung / Bellow Kit, steering system ALL TYPES</p>		<p>30221 53536-S1A-E01</p> 











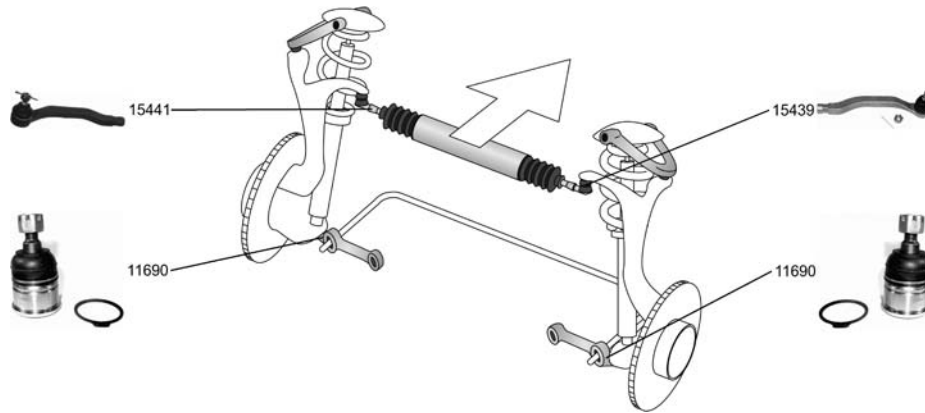



OE

HONDA

ACCORD VII Coupe (CG)

02.98 -



<p>Spurstangenkopf / Tie-rod End Gewindeart: mit Rechtsgewinde / Thread Type: with right-hand thread ALL TYPES</p>		<p>15439 53540-SM4-004</p>
		
<p>Spurstangenkopf / Tie-rod End Gewindeart: mit Rechtsgewinde / Thread Type: with right-hand thread ALL TYPES</p>		<p>15441 53560-SM4-004</p>
		
<p>Trag-/Führungsgelenk / Support-/ Steering Link ALL TYPES</p>		<p>11690 51220-SM4-013</p>
		
<p>Stange/Strebe, Stabilisator / Rod/Strut, stabiliser Pendelstange / Suspension Rod ALL TYPES</p>		<p>29795 51321-S84-A01</p>
<p>Stange/Strebe, Stabilisator / Rod/Strut, stabiliser Pendelstange / Suspension Rod ALL TYPES</p>		<p>29796 51320-S84-A01</p>
<p>Faltenbalsatz, Lenkung / Bellow Kit, steering system ALL TYPES</p>		<p>30221 53536-S1A-E01</p>
		
<p>Faltenbalsatz, Lenkung / Bellow Kit, steering system ALL TYPES</p>		<p>30234 53534-S84-A01</p>
		









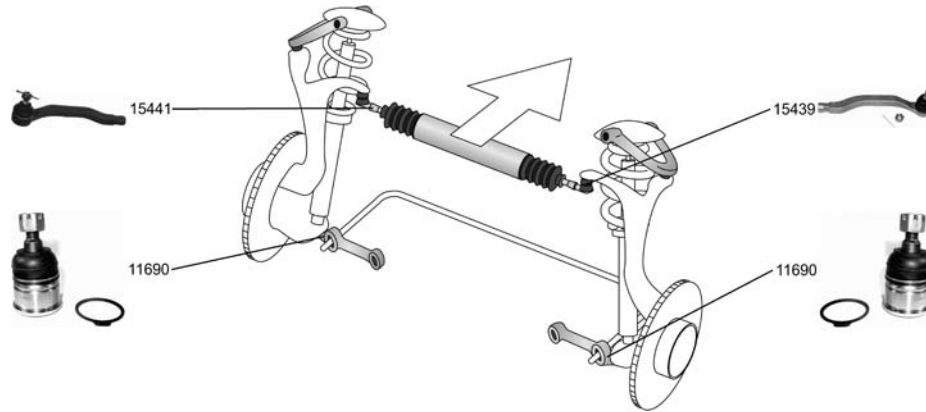





HONDA

ACCORD VII Hatchback/avec hayon
(CH)

12.99 -



Spurstangenkopf / Tie-rod End Gewindeart: mit Rechtsgewinde / Thread Type: with right-hand thread 1.8 i (CH6) 12.99 -		15439 53540-SM4-004 
Spurstangenkopf / Tie-rod End Gewindeart: mit Rechtsgewinde / Thread Type: with right-hand thread 1.8 i (CH6) 12.99 -		15441 53560-SM4-004 
Trag-/Führungsgelenk / Support-/ Steering Link 1.8 i (CH6) 12.99 -		11690 51220-SM4-013 
Stange/Strebe, Stabilisator / Rod/Strut, stabiliser Pendelstange / Suspension Rod 1.8 i (CH6) 12.99 - 2.0 (CH7) 12.99 - 2.3 (CL4) 11.00 -		29795 51321-S84-A01 
Stange/Strebe, Stabilisator / Rod/Strut, stabiliser Pendelstange / Suspension Rod 1.8 i (CH6) 12.99 - 2.0 (CH7) 12.99 - 2.3 (CL4) 11.00 -		29796 51320-S84-A01 
Faltenbalgsatz, Lenkung / Bellow Kit, steering system 1.8 i (CH6) 12.99 - 2.0 (CH7) 12.99 - 2.3 (CL4) 11.00 -		30221 53536-S1A-E01 





OE

HONDA

ACCORD VIII

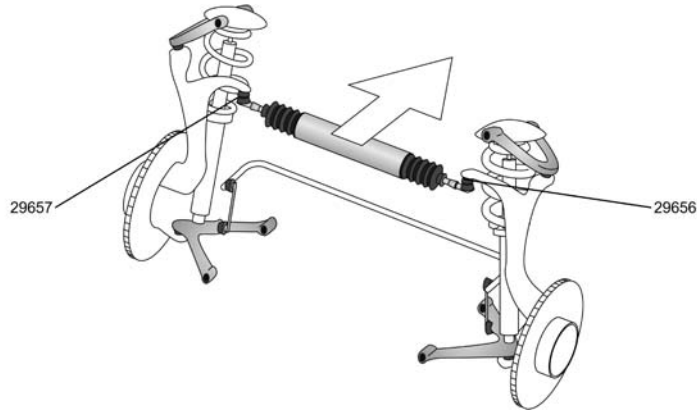
02.03 -





Spurstangenkopf / Tie-rod End ALL TYPES		29656	53540-SDA-A01
Spurstangenkopf / Tie-rod End ALL TYPES		29657	53560-SDA-A01

ACCORD VIII Tourer

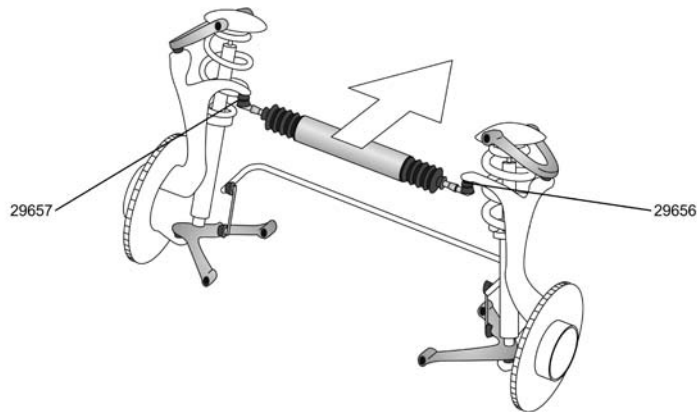
04.03 -



Spurstangenkopf / Tie-rod End ALL TYPES		29656	53540-SDA-A01
Spurstangenkopf / Tie-rod End ALL TYPES		29657	53560-SDA-A01









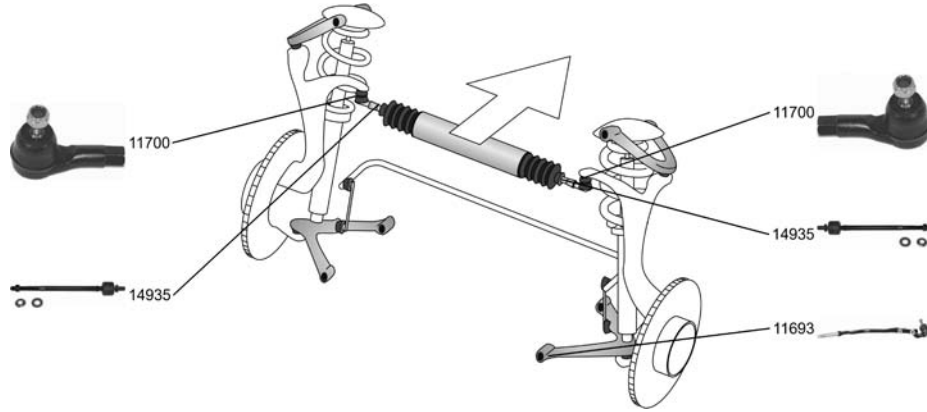

HONDA

CIVIC I Shuffle/Estate/Break (AN, AR)

10.83 - 10.87





<p>Spurstangenkopf / Tie-rod End Innengewinde [mm] / Inner Thread [mm]:M12x1,25 Gewindeart: mit Rechtsgewinde / Thread Type: with right-hand thread</p>		<p>11700 53540-SC2-004</p> 
<p>ALL TYPES</p>		
<p>Axialgelenk, Spurstange / Axial Rod, tie rod Gewindeart: mit Rechtsgewinde / Thread Type: with right-hand thread Gewindemaß / Thread Size:M12x1,25</p>		<p>14935 53521-SB2-013</p> 
<p>ALL TYPES</p>		
<p>Lenker, Radaufhängung / Track Control Arm</p>		<p>11693 51351-SD2-003</p> 
<p>ALL TYPES</p>		
<p>Faltenbaldsatz, Lenkung / Bellow Kit, steering system</p>		<p>30138 53534-634-020</p> 
<p>ALL TYPES</p>		

CIVIC II

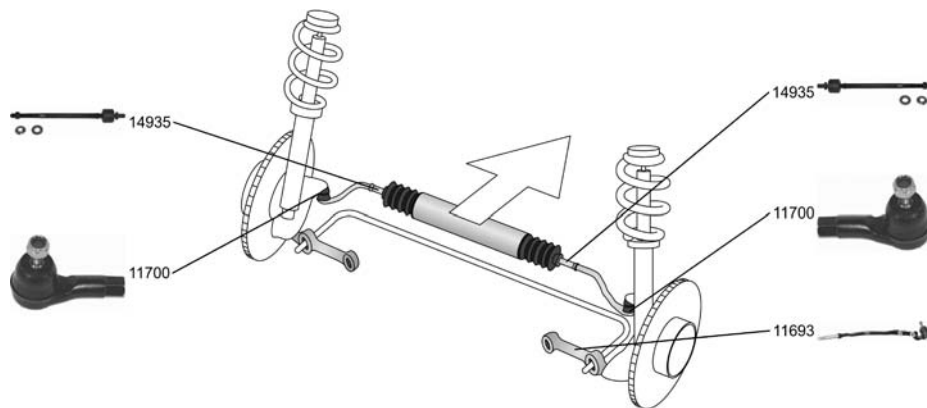
10.83 - 10.87







<p>Spurstangenkopf / Tie-rod End Innengewinde [mm] / Inner Thread [mm]:M12x1,25 Gewindeart: mit Rechtsgewinde / Thread Type: with right-hand thread</p>		<p>11700 53540-SC2-004</p> 
<p>ALL TYPES</p>		



OE



HONDA

CIVIC II Hatchback/avec hayon (AL, AJ, AG, AH) 10.83 - 10.87

	Faltenbalgsatz, Lenkung / Bellow Kit, steering system		30139	53534-SB4-951
	1.5 GL (AH) 10.83 - 10.87 1.5 GTI (AH) 03.86 - 10.87 1.5 GT (AH) 01.85 - 10.87			

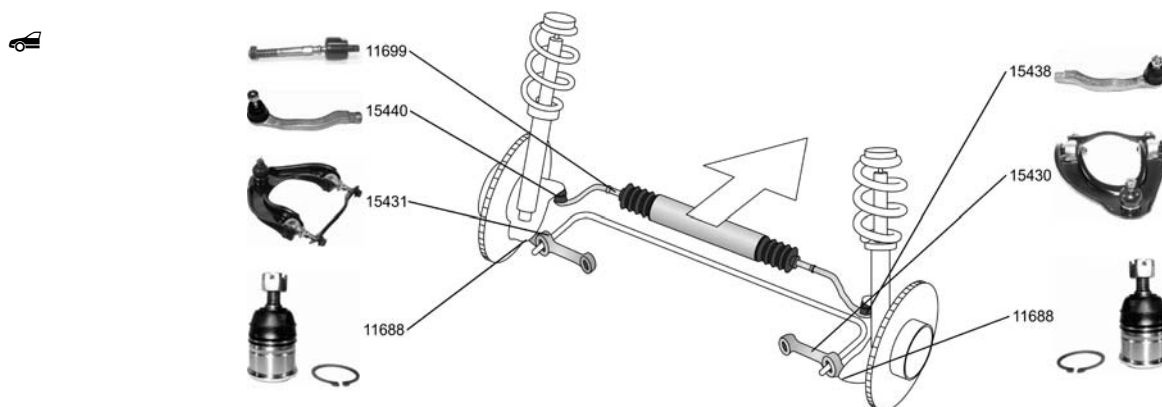
CIVIC II Shuttle/Estate/Break (EE) 01.88 - 02.95







	Spurstangenkopf / Tie-rod End Gewindeart: mit Rechtsgewinde / Thread Type: with right-hand thread		15438	53540-SR3-003
	1.5 i 16V (EE2) 01.88 - 11.91 1.6 i 16V 4WD (EE4) 01.88 - 02.95			
	Spurstangenkopf / Tie-rod End Gewindeart: mit Rechtsgewinde / Thread Type: with right-hand thread		15440	53560-SR3-003
	1.5 i 16V (EE2) 01.88 - 11.91 1.6 i 16V 4WD (EE4) 01.88 - 02.95			
	Axialgelenk, Spurstange / Axial Rod, tie rod		11699	53521-SH3-003
	1.5 i 16V (EE2) 01.88 - 11.91 1.6 i 16V 4WD (EE4) 01.88 - 02.95			
	Lenker, Radaufhängung / Track Control Arm		15430	51450-SH3-030
	1.5 i 16V (EE2) 01.88 - 11.91 1.6 i 16V 4WD (EE4) 01.88 - 02.95			
	Lenker, Radaufhängung / Track Control Arm		15431	51460-SH3-030
	1.5 i 16V (EE2) 01.88 - 11.91 1.6 i 16V 4WD (EE4) 01.88 - 02.95			
	Trag-/Führungsgelenk / Support-/ Steering Link		11688	51220-SK7-013
	1.5 i 16V (EE2) 01.88 - 11.91 1.6 i 16V 4WD (EE4) 01.88 - 02.95			



OE

HONDA

CIVIC II Shuttle/Estate/Break (EE) 01.88 - 02.95

 Faltenbalgsatz, Lenkung / Bellow Kit, steering system 1.5 i 16V (EE2) 01.88 - 11.91 1.6 i 16V 4WD (EE4) 01.88 - 02.95		30139 53534-SB4-951 
		

CIVIC III Stufenheck/Saloon/avec coffre (ED) 09.87 - 09.91

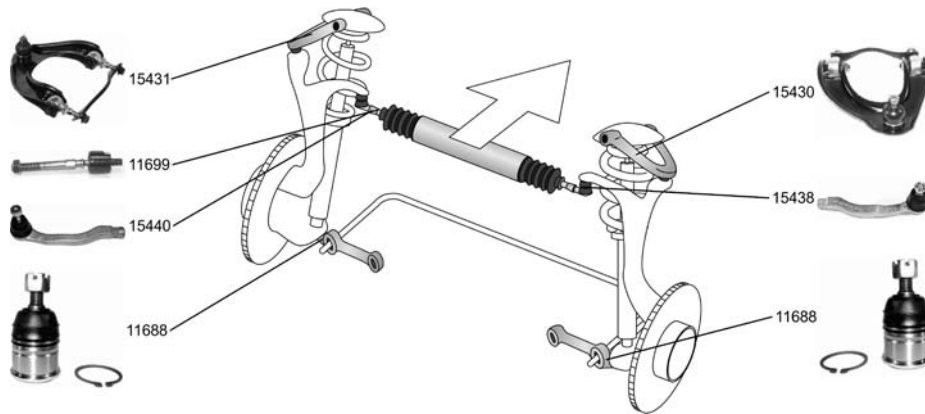



Spurstangenkopf / Tie-rod End Gewindeart: mit Rechtsgewinde / Thread Type: with right-hand thread ALL TYPES ausser/except for : 1.3 10.87 - 12.89 1.5 i 16V 10.87 - 09.91 1.4 (ED2) 12.89 - 09.91		15438 53540-SR3-003 
Spurstangenkopf / Tie-rod End Gewindeart: mit Rechtsgewinde / Thread Type: with right-hand thread ALL TYPES ausser/except for : 1.3 10.87 - 12.89 1.5 i 16V 10.87 - 09.91 1.4 (ED2) 12.89 - 09.91		15440 53560-SR3-003 
Axialgelenk, Spurstange / Axial Rod, tie rod ALL TYPES ausser/except for : 1.3 10.87 - 12.89 1.5 i 16V 10.87 - 09.91 1.4 (ED2) 12.89 - 09.91		11699 53521-SH3-003 
Lenker, Radaufhängung / Track Control Arm ALL TYPES ausser/except for : 1.3 10.87 - 12.89 1.5 i 16V 10.87 - 09.91 1.4 (ED2) 12.89 - 09.91		15430 51450-SH3-030 
Lenker, Radaufhängung / Track Control Arm ALL TYPES ausser/except for : 1.3 10.87 - 12.89 1.5 i 16V 10.87 - 09.91 1.4 (ED2) 12.89 - 09.91		15431 51460-SH3-030 
Trag-/Führungsgelenk / Support-/ Steering Link ALL TYPES ausser/except for : 1.3 10.87 - 12.89 1.5 i 16V 10.87 - 09.91 1.4 (ED2) 12.89 - 09.91		11688 51220-SK7-013 



HONDA

CIVIC III Stufenheck/Saloon/avec coffre (ED)





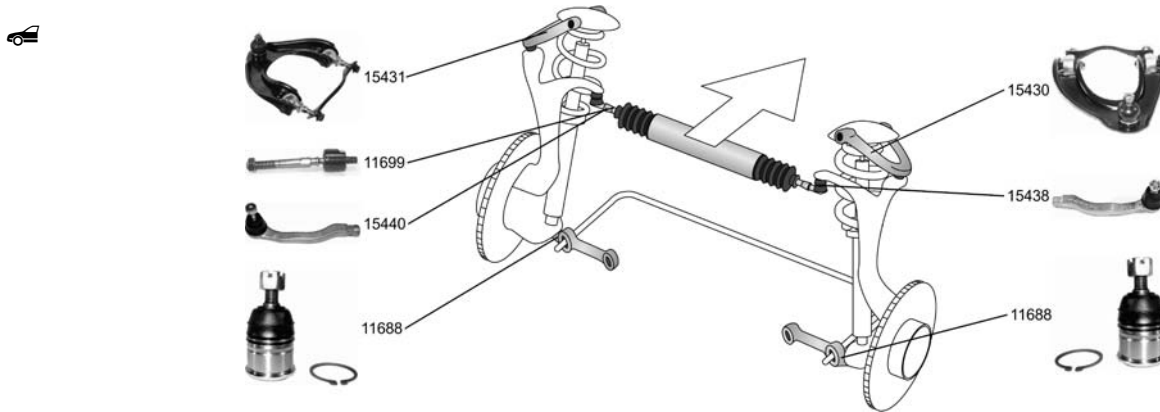

09.87 - 09.91

	Faltenbalgsatz, Lenkung / Bellow Kit, steering system		30139	53534-SB4-951
	1.3	10.87 - 12.89		
	1.4 L (ED2)	10.87 - 12.89		
	1.5 i 16V (ED3)	10.87 - 09.91		
	1.6 i 16V 4x4	10.89 - 09.91		
1.6 i 16V (ED4), 81 kW	10.87 - 09.91			

CIVIC III Hatchback/avec hayon (EC, ED, EE)

09.87 - 09.91















	Spurstangenkopf / Tie-rod End Gewindeart: mit Rechtsgewinde / Thread Type: with right-hand thread		15438	53540-SR3-003
	1.3 (EC8)	10.87 - 12.89		
	1.3 16 V (EC8) KAT	09.89 - 09.91		
	1.4 L (EC9)	10.87 - 12.89		
	1.5 i 16V (ED6)	10.88 - 09.91		
	1.6 i 16V (ED7)	10.87 - 09.91		
	1.6 i 16V	09.87 - 09.91		
	1.6 i 16V Vtec (EE9)	10.89 - 09.91		
Spurstangenkopf / Tie-rod End Gewindeart: mit Rechtsgewinde / Thread Type: with right-hand thread		15440		
1.3 (EC8)	10.87 - 12.89			
1.3 16 V (EC8) KAT	09.89 - 09.91			
1.4 L (EC9)	10.87 - 12.89			
1.5 i 16V (ED6)	10.88 - 09.91			
1.6 i 16V (ED7)	10.87 - 09.91			
1.6 i 16V	09.87 - 09.91			
1.6 i 16V Vtec (EE9)	10.89 - 09.91			
Axialgelenk, Spurstange / Axial Rod, tie rod				11699
1.3 (EC8)	10.87 - 12.89			
1.3 16 V (EC8) KAT	09.89 - 09.91			
1.4 L (EC9)	10.87 - 12.89			
1.5 i 16V (ED6)	10.88 - 09.91			
1.6 i 16V (ED7)	10.87 - 09.91			
1.6 i 16V	09.87 - 09.91			
1.6 i 16V Vtec (EE9)	10.89 - 09.91			
Lenker, Radaufhängung / Track Control Arm				15430
1.3 (EC8)	10.87 - 12.89			
1.3 16 V (EC8) KAT	09.89 - 09.91			
1.4 L (EC9)	10.87 - 12.89			
1.5 i 16V (ED6)	10.88 - 09.91			
1.6 i 16V (ED7)	10.87 - 09.91			
1.6 i 16V	09.87 - 09.91			
1.6 i 16V Vtec (EE9)	10.89 - 09.91			
Lenker, Radaufhängung / Track Control Arm				15431
1.3 (EC8)	10.87 - 12.89			
1.3 16 V (EC8) KAT	09.89 - 09.91			
1.4 L (EC9)	10.87 - 12.89			
1.5 i 16V (ED6)	10.88 - 09.91			
1.6 i 16V (ED7)	10.87 - 09.91			
1.6 i 16V	09.87 - 09.91			
1.6 i 16V Vtec (EE9)	10.89 - 09.91			



OE





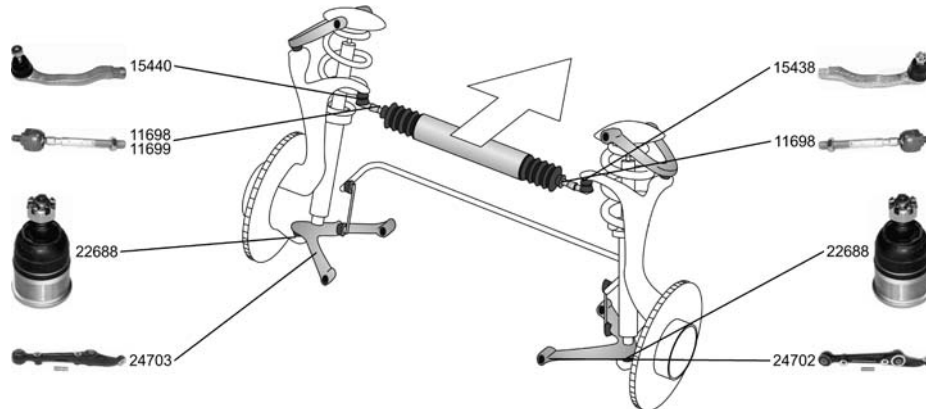

HONDA

CIVIC III Hatchback/avec hayon (EC, ED, EE) 09.87 - 09.91

<p> Trag-/Führungsgelenk / Support-/ Steering Link</p> <p>1.3 (EC8) 10.87 - 12.89 1.3 16 V (EC8) KAT 09.89 - 09.91 1.4 L (EC9) 10.87 - 12.89 1.5 i 16V (ED6) 10.88 - 09.91 1.6 i 16V (ED7) 10.87 - 09.91 1.6 i 16V 09.87 - 09.91 1.6 i 16V Vtec (EE9) 10.89 - 09.91</p>	<p></p>	<p>11688 51220-SK7-013</p> 
<p>Faltenbalgsatz, Lenkung / Bellow Kit, steering system</p> <p>1.6 i 16V Vtec (EE9) 10.89 - 09.91</p>	<p> </p>	<p>30138 53534-634-020</p> 
<p>Faltenbalgsatz, Lenkung / Bellow Kit, steering system</p> <p>1.3 (EC8) 10.87 - 12.89 1.3 16 V (EC8) KAT 09.89 - 09.91 1.4 L (EC9) 10.87 - 12.89 1.6 i 16V (ED7) 10.87 - 09.91 1.6 i 16V Vtec (EE9) 10.89 - 09.91</p>	<p> </p>	<p>30139 53534-SB4-951</p> 
<p>Faltenbalgsatz, Lenkung / Bellow Kit, steering system</p> <p>1.5 i 16V (ED6) 10.88 - 09.91</p>	<p> </p>	<p>30147 53534-SV4-N01</p> 

CIVIC IV (EG, EH) 10.91 - 11.95



















<p>Spurstangenkopf / Tie-rod End Gewindeart: mit Rechtsgewinde / Thread Type: with right-hand thread ALL TYPES</p>	<p></p>	<p>15438 53540-SR3-003</p> 
<p>Spurstangenkopf / Tie-rod End Gewindeart: mit Rechtsgewinde / Thread Type: with right-hand thread ALL TYPES</p>	<p></p>	<p>15440 53560-SR3-003</p> 
<p>Axialgelenk, Spurstange / Axial Rod, tie rod ALL TYPES</p>	<p></p>	<p>11698 53010-SR3-010</p> 



HONDA

CIVIC IV (EG, EH)



10.91 - 11.95

 Axialgelenk, Spurstange / Axial Rod, tie rod 1.6 16V Vtec (EH9) 1.6 VTI (EG9)	10.91 - 11.95		11699 53521-SH3-003 
	10.91 - 11.95		
Lenker, Radaufhängung / Track Control Arm ALL TYPES			24702 51350-SR3-010 
Lenker, Radaufhängung / Track Control Arm ALL TYPES			24703 51360-SR3-010 
Trag-/Führungsgelenk / Support-/ Steering Link ALL TYPES			22688 51220-SR3-003 
Faltenbalgsatz, Lenkung / Bellow Kit, steering system ALL TYPES			30147 53534-SV4-N01 
			
 Lenker, Radaufhängung / Track Control Arm ALL TYPES			24708 52390-SR3-000 
Lenker, Radaufhängung / Track Control Arm ALL TYPES			24709 52400-SR3-000 

CIVIC IV Coupe (EJ)

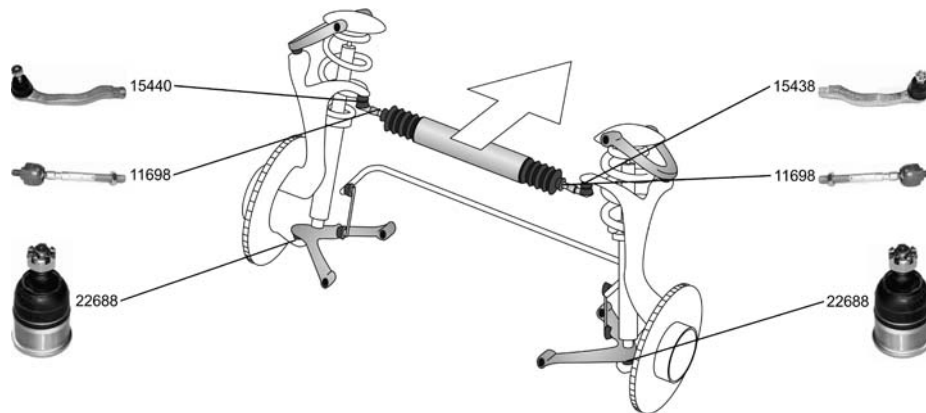
01.94 - 03.96



Spurstangenkopf / Tie-rod End Gewindeart: mit Rechtsgewinde / Thread Type: with right-hand thread ALL TYPES			15438 53540-SR3-003 
--	--	---	--

















OE

HONDA

CIVIC IV Coupe (EJ)



01.94 - 03.96

	Spurstangenkopf / Tie-rod End Gewindeart: mit Rechtsgewinde / Thread Type: with right-hand thread ALL TYPES		15440 53560-SR3-003	
	Axialgelenk, Spurstange / Axial Rod, tie rod ALL TYPES		11698 53010-SR3-010	
	Trag-/Führungsgelenk / Support-/ Steering Link ALL TYPES		22688 51220-SR3-003	
	Faltenbalsatz, Lenkung / Bellow Kit, steering system ALL TYPES	 	30147 53534-SV4-N01	
	Lenker, Radaufhängung / Track Control Arm ALL TYPES		24708 52390-SR3-000	
	Lenker, Radaufhängung / Track Control Arm ALL TYPES		24709 52400-SR3-000	

CIVIC IV Fastback (MA, MB)

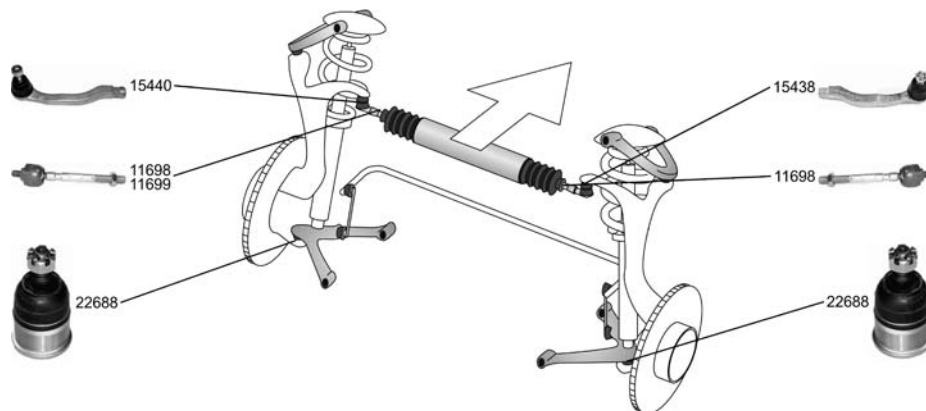
09.94 - 01.97



Spurstangenkopf / Tie-rod End Gewindeart: mit Rechtsgewinde / Thread Type: with right-hand thread ALL TYPES		15438 53540-SR3-003	
--	---	----------------------------	---



HONDA

CIVIC IV Fastback (MA, MB)

09.94 - 01.97

	Spurstangenkopf / Tie-rod End Gewindeart: mit Rechtsgewinde / Thread Type: with right-hand thread ALL TYPES		15440 53560-SR3-003	
	Axialgelenk, Spurstange / Axial Rod, tie rod ALL TYPES		11698 53010-SR3-010	
	Axialgelenk, Spurstange / Axial Rod, tie rod 1.6 i (MB1) 09.94 - 01.97 1.6 i Vtec (MB1) 09.94 - 01.97		11699 53521-SH3-003	
	Trag-/Führungsgelenk / Support-/ Steering Link ALL TYPES		22688 51220-SR3-003	
	Faltenbalgsatz, Lenkung / Bellow Kit, steering system ALL TYPES		30147 53534-SV4-N01	
	Lenker, Radaufhängung / Track Control Arm 1.4 i (MA8), 66 kW 09.94 - 01.97 1.5 i Vtec-E (MA9) 09.94 - 01.97 1.6 i (MB1) 09.94 - 01.97 1.6 i Vtec (MB1) 09.94 - 01.97		24708 52390-SR3-000	
	Lenker, Radaufhängung / Track Control Arm 1.4 i (MA8), 66 kW 09.94 - 01.97 1.5 i Vtec-E (MA9) 09.94 - 01.97 1.6 i (MB1) 09.94 - 01.97 1.6 i Vtec (MB1) 09.94 - 01.97		24709 52400-SR3-000	











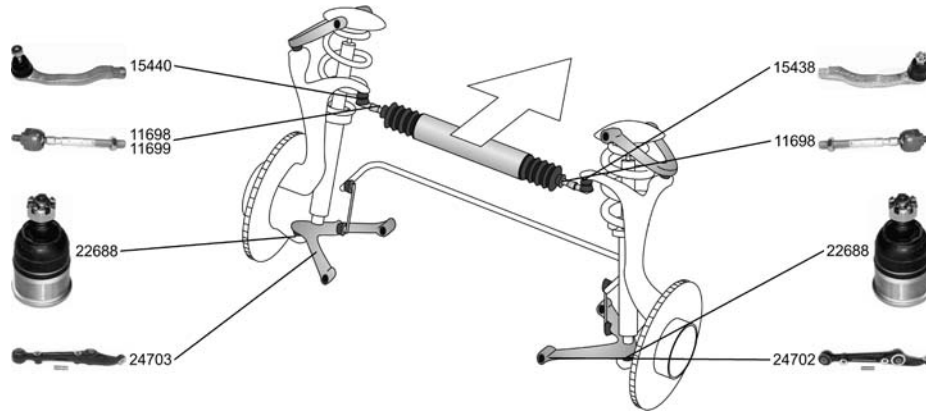







OE

HONDA

**CIVIC IV Hatchback/avec hayon
(EG)**

10.91 - 11.95







<p>Spurstangenkopf / Tie-rod End Gewindeart: mit Rechtsgewinde / Thread Type: with right-hand thread</p> <p>1.3 16V (EG3) 10.91 - 11.95 1.5 i 16V (EG4) 10.91 - 11.95 1.6 16V Vtec (EG5) 10.91 - 11.95 1.6 VTi 16V (EG6) 10.91 - 11.95</p>		<p>15438 53540-SR3-003</p> 
<p>Spurstangenkopf / Tie-rod End Gewindeart: mit Rechtsgewinde / Thread Type: with right-hand thread</p> <p>1.3 16V (EG3) 10.91 - 11.95 1.5 i 16V (EG4) 10.91 - 11.95 1.6 16V Vtec (EG5) 10.91 - 11.95 1.6 VTi 16V (EG6) 10.91 - 11.95</p>		<p>15440 53560-SR3-003</p> 
<p>Axialgelenk, Spurstange / Axial Rod, tie rod</p> <p>1.3 16V (EG3) 10.91 - 11.95 1.5 i 16V (EG4) 10.91 - 11.95 1.6 16V Vtec (EG5) 10.91 - 11.95 1.6 VTi 16V (EG6) 10.91 - 11.95</p>		<p>11698 53010-SR3-010</p> 
<p>Axialgelenk, Spurstange / Axial Rod, tie rod</p> <p>1.3 16V (EG3) 10.91 - 11.95 1.6 16V Vtec (EG5) 10.91 - 11.95 1.6 VTi 16V (EG6) 10.91 - 11.95</p>		<p>11699 53521-SH3-003</p> 
<p>Lenker, Radaufhängung / Track Control Arm</p> <p>1.3 16V (EG3) 10.91 - 11.95 1.5 i 16V (EG4) 10.91 - 11.95 1.6 16V Vtec (EG5) 10.91 - 11.95 1.6 VTi 16V (EG6) 10.91 - 11.95</p>		<p>24702 51350-SR3-010</p> 
<p>Lenker, Radaufhängung / Track Control Arm</p> <p>1.3 16V (EG3) 10.91 - 11.95 1.5 i 16V (EG4) 10.91 - 11.95 1.6 16V Vtec (EG5) 10.91 - 11.95 1.6 VTi 16V (EG6) 10.91 - 11.95</p>		<p>24703 51360-SR3-010</p> 
<p>Trag-/Führungsgelenk / Support-/ Steering Link</p> <p>1.3 16V (EG3) 10.91 - 11.95 1.5 i 16V (EG4) 10.91 - 11.95 1.6 16V Vtec (EG5) 10.91 - 11.95 1.6 VTi 16V (EG6) 10.91 - 11.95</p>		<p>22688 51220-SR3-003</p> 
<p>Faltenbalgsatz, Lenkung / Bellow Kit, steering system</p> <p>1.3 16V (EG3) 10.91 - 11.95</p> <p>1.5 i 16V (EG4) 10.91 - 11.95 1.6 16V Vtec (EG5) 10.91 - 11.95 1.6 VTi 16V (EG6) 10.91 - 11.95</p>		<p>30147 53534-SV4-N01</p> 



HONDA

CIVIC IV Hatchback/avec hayon (EG)









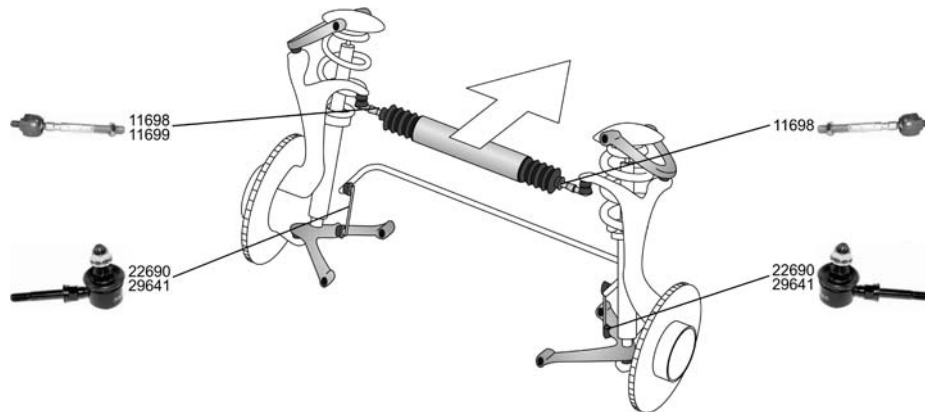



10.91 - 11.95

	Lenker, Radaufhängung / Track Control Arm			24708	52390-SR3-000
	1.3 16V (EG3)	10.91 - 11.95			
	1.5 i 16V (EG4)	10.91 - 11.95			
	1.6 16V Vtec (EG5)	10.91 - 11.95			
	1.6 VTi 16V (EG6)	10.91 - 11.95			
	Lenker, Radaufhängung / Track Control Arm			24709	52400-SR3-000
	1.3 16V (EG3)	10.91 - 11.95			
	1.5 i 16V (EG4)	10.91 - 11.95			
	1.6 16V Vtec (EG5)	10.91 - 11.95			
	1.6 VTi 16V (EG6)	10.91 - 11.95			

CIVIC V (EJ9, EK3/4)

11.95 - 02.01



	Axialgelenk, Spurstange / Axial Rod, tie rod			11698	53010-SR3-010			
	1.5 i (EK3)	11.95 - 02.01						
	Axialgelenk, Spurstange / Axial Rod, tie rod						11699	53521-SH3-003
	1.4 i (EJ9)	11.95 - 02.01						
	Stange/Strebe, Stabilisator / Rod/Strut, stabiliser							
	Pendelstange / Suspension Rod							
	ALL TYPES						29641	51320-S04-003
	Stange/Strebe, Stabilisator / Rod/Strut, stabiliser							
	Pendelstange / Suspension Rod							
	1.4 i (EJ9)	11.95 - 02.01						
	1.6 i Vtec	11.95 - 02.01						
	1.6 VTi (EK4)	11.95 - 02.01						
	Lenker, Radaufhängung / Track Control Arm			24708	52390-SR3-000			
	ALL TYPES							
	Lenker, Radaufhängung / Track Control Arm						24709	52400-SR3-000
	ALL TYPES							











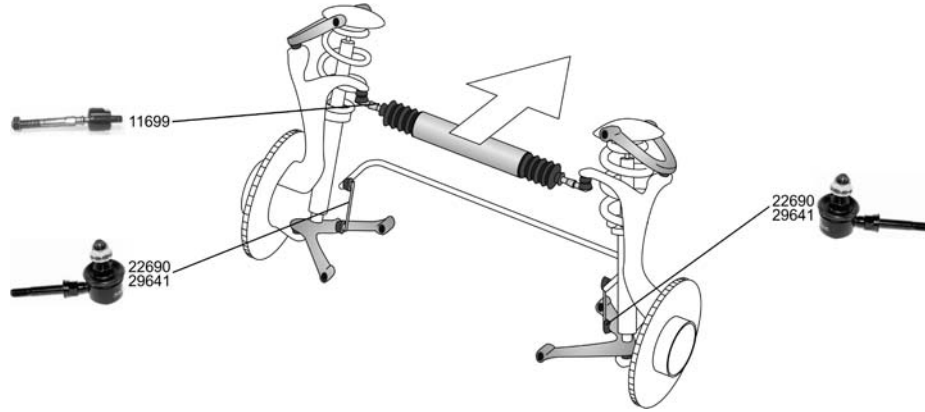



OE

HONDA

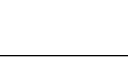
CIVIC V Aerodeck/Estate/Break (MC)

04.98 - 02.01





Axialgelenk, Spurstange / Axial Rod, tie rod ALL TYPES		11699 53521-SH3-003 
Stange/Strebe, Stabilisator / Rod/Strut, stabiliser Pendelstange / Suspension Rod ALL TYPES		22690 51320-ST7-003 
Stange/Strebe, Stabilisator / Rod/Strut, stabiliser Pendelstange / Suspension Rod ALL TYPES		29641 51320-S04-003 
 Lenker, Radaufhängung / Track Control Arm ALL TYPES		24708 52390-SR3-000 
Lenker, Radaufhängung / Track Control Arm ALL TYPES		24709 52400-SR3-000 

CIVIC V Coupe (EJ6, EJ8)

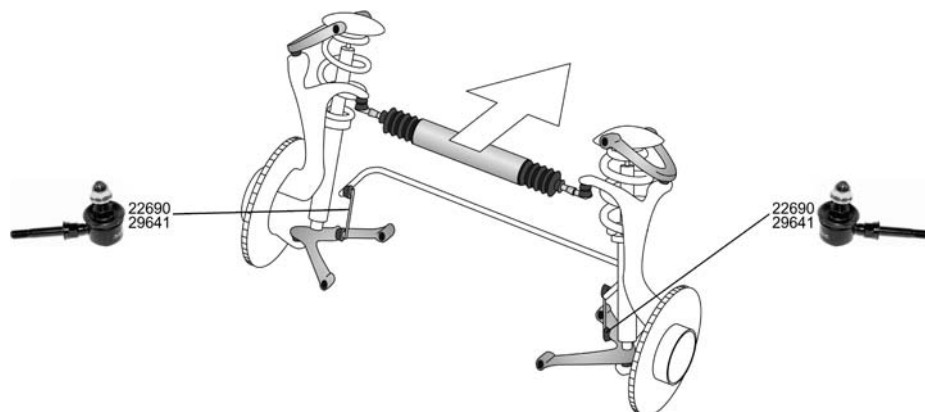
03.96 - 12.00





Stange/Strebe, Stabilisator / Rod/Strut, stabiliser Pendelstange / Suspension Rod 1.6 i 1.6 i Vtec, 92 kW		22690 51320-ST7-003 
03.96 - 03.00 03.96 - 03.00		



HONDA

CIVIC V Coupe (EJ6, EJ8)









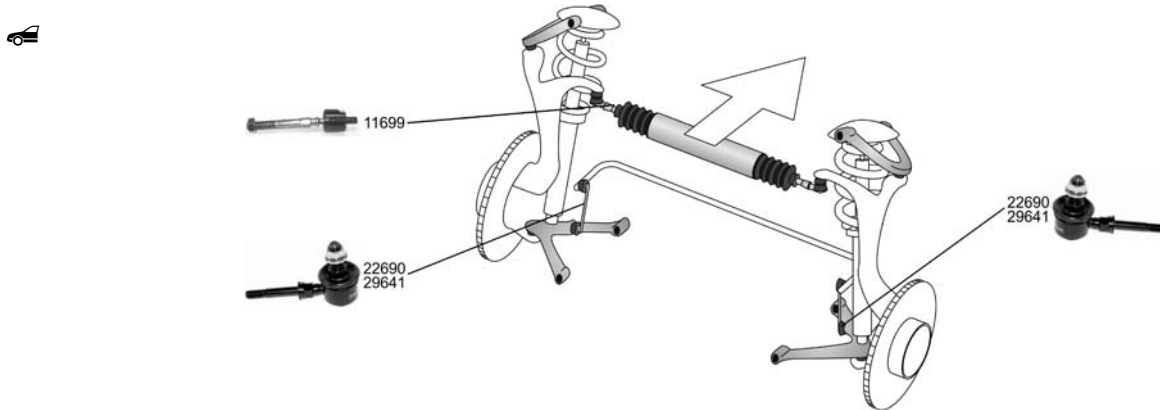

03.96 - 12.00

	Stange/Strebe, Stabilisator / Rod/Strut, stabiliser Pendelstange / Suspension Rod		29641	51320-S04-003	
	1.6 i				03.96 - 03.00
	1.6 i Vtec, 92 kW				03.96 - 03.00

CIVIC V Fastback (MB)

01.97 - 02.01



	Axialgelenk, Spurstange / Axial Rod, tie rod		11699	53521-SH3-003
	ALL TYPES ausser/except for :			
	1.6 16V (MB4) 01.97 - 02.01 1.6 VTI 01.97 - 02.01			
	Stange/Strebe, Stabilisator / Rod/Strut, stabiliser Pendelstange / Suspension Rod		22690	51320-ST7-003
	ALL TYPES			
	Stange/Strebe, Stabilisator / Rod/Strut, stabiliser Pendelstange / Suspension Rod		29641	51320-S04-003
	ALL TYPES			
	Lenker, Radaufhängung / Track Control Arm		24708	52390-SR3-000
	ALL TYPES			
	Lenker, Radaufhängung / Track Control Arm		24709	52400-SR3-000
	ALL TYPES			











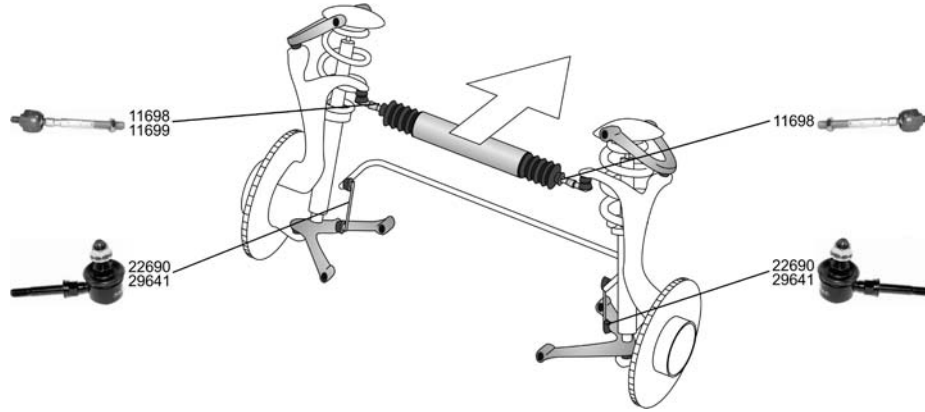





OE

HONDA

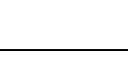
**CIVIC V Hatchback/avec hayon
(EJ9, EK1/3/4)**

11.95 - 02.01



<p>Axialgelenk, Spurstange / Axial Rod, tie rod</p> <p>1.4 i (EJ9) 11.95 - 02.01 1.5 i (EK3) 11.95 - 02.01</p>		<p>11698 53010-SR3-010</p> 
<p>Axialgelenk, Spurstange / Axial Rod, tie rod</p> <p>1.4 i (EJ9) 11.95 - 02.01 1.4 i S (EJ9) 11.95 - 02.01</p>		<p>11699 53521-SH3-003</p> 
<p>Stange/Strebe, Stabilisator / Rod/Strut, stabiliser Pendelstange / Suspension Rod ALL TYPES</p>		<p>22690 51320-ST7-003</p> 
<p>Stange/Strebe, Stabilisator / Rod/Strut, stabiliser Pendelstange / Suspension Rod ALL TYPES</p>		<p>29641 51320-S04-003</p> 
<p> Lenker, Radaufhängung / Track Control Arm ALL TYPES</p>		<p>24708 52390-SR3-000</p> 
<p>Lenker, Radaufhängung / Track Control Arm ALL TYPES</p>		<p>24709 52400-SR3-000</p> 



HONDA

CIVIC VI

02.01 -

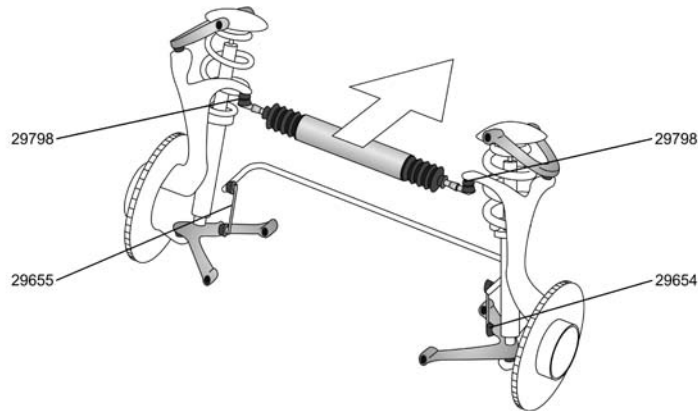

Spurstangenkopf / Tie-rod End		↔	29798	53541-S5A-003
1.3 IMA	01.04 -			
1.4 (ES4)	02.01 -			
1.6	02.01 -			
Stange/Strebe, Stabilisator / Rod/Strut, stabiliser		↻	29654	51320-S5A-003
Pendelstange / Suspension Rod				
1.3 IMA	01.04 -			
1.4 (ES4)	02.01 -			
1.6	02.01 -			
Stange/Strebe, Stabilisator / Rod/Strut, stabiliser		↻	29655	51321-S5A-003
Pendelstange / Suspension Rod				
1.3 IMA	01.04 -			
1.4 (ES4)	02.01 -			
1.6	02.01 -			

CIVIC VI Coupe (EM)

02.01 - 12.05

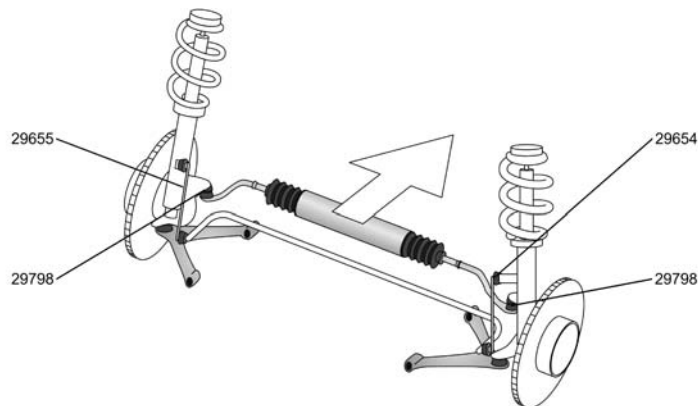

Spurstangenkopf / Tie-rod End		↔	29798	53541-S5A-003
ALL TYPES				
Stange/Strebe, Stabilisator / Rod/Strut, stabiliser		↻	29654	51320-S5A-003
Pendelstange / Suspension Rod				
ALL TYPES				
Stange/Strebe, Stabilisator / Rod/Strut, stabiliser		↻	29655	51321-S5A-003
Pendelstange / Suspension Rod				
ALL TYPES				







OE

HONDA

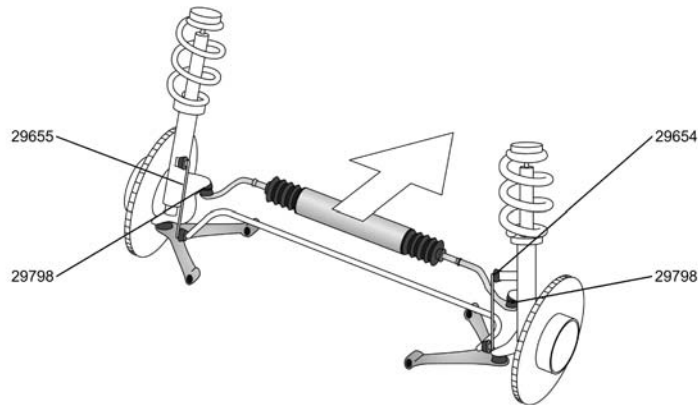
CIVIC VI Hatchback (EU_, EP_)

02.01 -





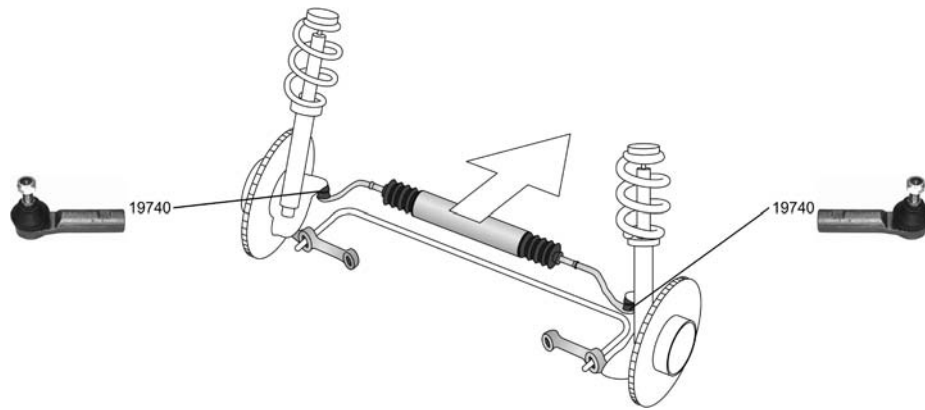

Spurstangenkopf / Tie-rod End		29798	53541-S5A-003
ALL TYPES ausser/except for : 1.4 i	02.01 -		
Stange/Strebe, Stabilisator / Rod/Strut, stabiliser Pendelstange / Suspension Rod		29654	51320-S5A-003
ALL TYPES			
Stange/Strebe, Stabilisator / Rod/Strut, stabiliser Pendelstange / Suspension Rod		29655	51321-S5A-003
ALL TYPES			

CONCERTO (HW)

08.89 - 10.96



Spurstangenkopf / Tie-rod End mit Zubehör / With accessories	 	19740	53540-SK3-E01
1.4, 66 kW	08.89 - 10.91		
1.5 i 16V	08.89 - 03.95		
1.6 16V	08.89 - 03.95		
1.6 i 16V, 82 kW	08.89 - 03.95		
1.6 i 16V, 90 kW	08.89 - 03.95		
Achskörperlager / Mounting, axle body	 (x2)	29991	
1.4, 66 kW	08.89 - 10.91		
1.5 i 16V	08.89 - 03.95		
1.6 16V	08.89 - 03.95		
1.6 i 16V, 82 kW	08.89 - 03.95		
1.6 i 16V, 90 kW	08.89 - 03.95		



HONDA

CRX II (ED, EE)

10.87 - 02.92

<p> Spurstangenkopf / Tie-rod End Gewindeart: mit Rechtsgewinde / Thread Type: with right-hand thread</p> <p>1.6 i 16V (ED9) 10.87 - 02.92 1.6 i 16V Vtec (EE8) 10.89 - 02.92</p>		<p>15440 53560-SR3-003</p> 
<p>Axialgelenk, Spurstange / Axial Rod, tie rod</p> <p>1.6 i 16V (ED9) 10.87 - 02.92 1.6 i 16V Vtec (EE8) 10.89 - 02.92</p>		<p>11699 53521-SH3-003</p> 
<p>Lenker, Radaufhängung / Track Control Arm</p> <p>1.6 i 16V (ED9) 10.87 - 02.92 1.6 i 16V Vtec (EE8) 10.89 - 02.92</p>		<p>15430 51450-SH3-030</p> 
<p>Lenker, Radaufhängung / Track Control Arm</p> <p>1.6 i 16V (ED9) 10.87 - 02.92 1.6 i 16V Vtec (EE8) 10.89 - 02.92</p>		<p>15431 51460-SH3-030</p> 
<p>Trag-/Führungsgelenk / Support-/ Steering Link</p> <p>1.6 i 16V (ED9) 10.87 - 02.92 1.6 i 16V Vtec (EE8) 10.89 - 02.92</p>		<p>11688 51220-SK7-013</p> 
<p>Trag-/Führungsgelenk / Support-/ Steering Link</p> <p>1.6 i 16V (ED9) 10.87 - 02.92 1.6 i 16V Vtec (EE8) 10.89 - 02.92</p>		<p>22688 51220-SR3-003</p> 
<p>Faltenbalgsatz, Lenkung / Bellow Kit, steering system</p> <p>1.6 i 16V (ED9) 10.87 - 02.92 1.6 i 16V Vtec (EE8) 10.89 - 02.92</p>	 	<p>30139 53534-SB4-951</p> 







OE

HONDA

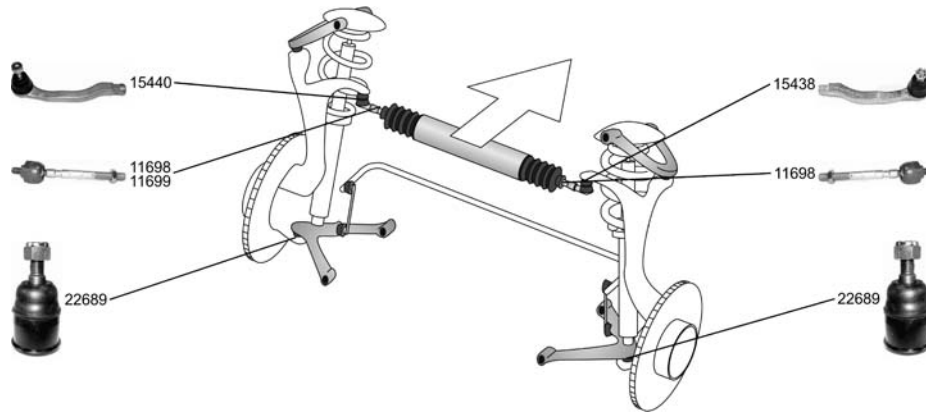
CRX III (EH, EG)

03.92 - 12.98





Spurstangenkopf / Tie-rod End Gewindeart: mit Rechtsgewinde / Thread Type: with right-hand thread ALL TYPES		15438 53540-SR3-003 
Spurstangenkopf / Tie-rod End Gewindeart: mit Rechtsgewinde / Thread Type: with right-hand thread ALL TYPES		15440 53560-SR3-003 
Axialgelenk, Spurstange / Axial Rod, tie rod ALL TYPES		11698 53010-SR3-010 
Axialgelenk, Spurstange / Axial Rod, tie rod ALL TYPES		11699 53521-SH3-003 
Trag-/Führungsgelenk / Support-/ Steering Link ALL TYPES		22689 51220-SR3-013 
Faltenbalsatz, Lenkung / Bellow Kit, steering system ALL TYPES	 	30139 53534-SB4-951 

INTEGRA (DA_)





10.85 - 08.89



Faltenbalsatz, Lenkung / Bellow Kit, steering system ALL TYPES	 	30139 53534-SB4-951 
--	--	--









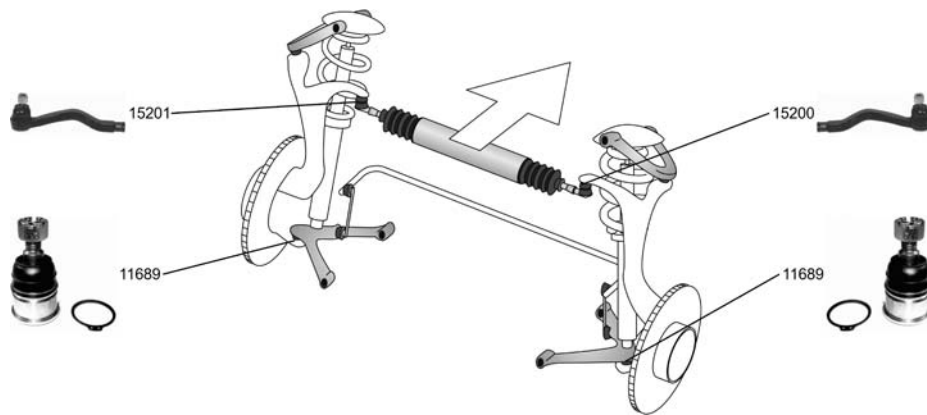

HONDA

JAZZ (AA)		10.83 - 10.86	
 Spurstangenkopf / Tie-rod End Innengewinde [mm] / Inner Thread [mm]:M12x1,25 Gewindeart: mit Rechtsgewinde / Thread Type: with right-hand thread ALL TYPES		11700 53540-SC2-004	
		14935 53521-SB2-013	
Axialgelenk, Spurstange / Axial Rod, tie rod Gewindeart: mit Rechtsgewinde / Thread Type: with right-hand thread Gewindemaß / Thread Size:M12x1,25 ALL TYPES			

LEGEND I (HS, KA) 01.86 - 12.90



Spurstangenkopf / Tie-rod End Gewindeart: mit Rechtsgewinde / Thread Type: with right-hand thread Gewindemaß / Thread Size:M12x1,5 2.5 i (HS) 01.86 - 06.88 2.7 i 24V (KA4) 01.88 - 12.90		15200 53540-SD4-003	
		15201 53560-SD4-003	
Trag-/Führungsgelenk / Support-/ Steering Link 2.5 i (HS) 01.86 - 06.88 2.7 i 24V (KA4) 01.88 - 12.90		11689 51220-SD4-023	
		30139 53534-SB4-951	
Faltenbalgsatz, Lenkung / Bellow Kit, steering system 2.5 i (HS) 01.86 - 06.88 2.7 i 24V (KA4) 01.88 - 12.90			
			









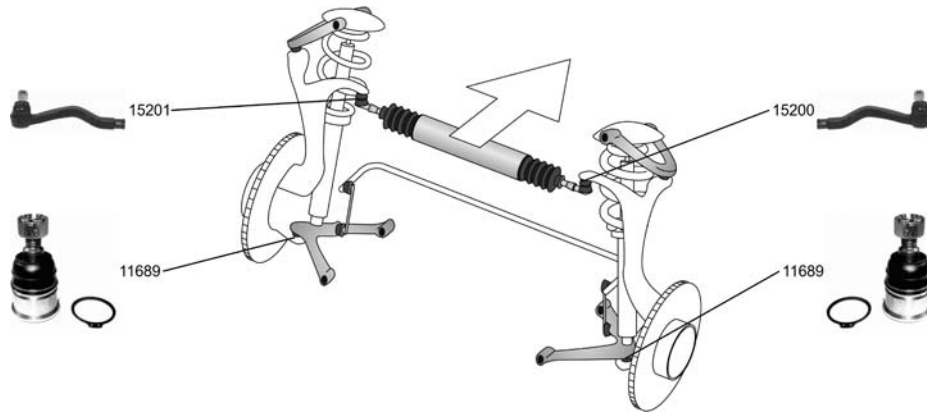

OE

HONDA

LEGEND I Coupe (KA3)

10.87 - 12.90





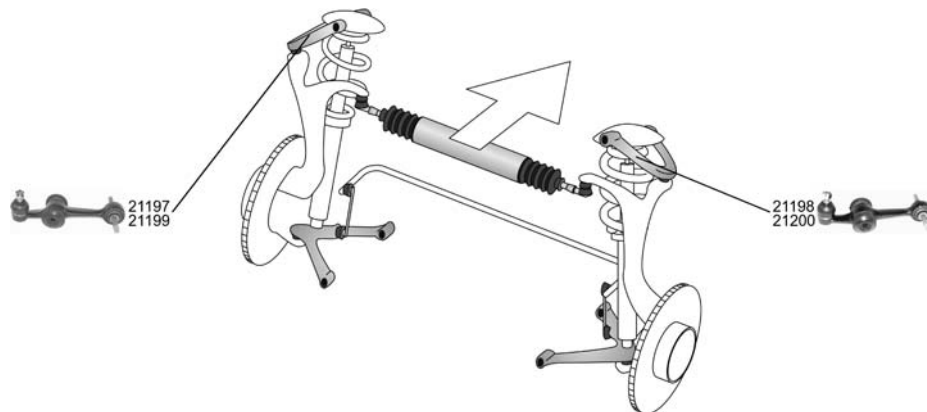

<p>Spurstangenkopf / Tie-rod End Gewindeart: mit Rechtsgewinde / Thread Type: with right-hand thread Gewindemaß / Thread Size:M12x1,5 ALL TYPES</p>		<p>15200 53540-SD4-003</p> 
<p>Spurstangenkopf / Tie-rod End Gewindeart: mit Rechtsgewinde / Thread Type: with right-hand thread Gewindemaß / Thread Size:M12x1,25 ALL TYPES</p>		<p>15201 53560-SD4-003</p> 
<p>Trag-/Führungsgelenk / Support-/ Steering Link ALL TYPES</p>		<p>11689 51220-SD4-023</p> 
<p>Faltenbaldsatz, Lenkung / Bellow Kit, steering system ALL TYPES</p>		<p>30139 53534-SB4-951</p> 

LEGEND II (KA7)

01.91 - 02.96



<p>Lenker, Radaufhängung / Track Control Arm ALL TYPES</p>		<p>21197 52400-SP0-013</p> 
<p>Lenker, Radaufhängung / Track Control Arm ALL TYPES</p>		<p>21198 52390-SP0-013</p> 







OE

HONDA

LEGEND II (KA7)





01.91 - 02.96

	Lenker, Radaufhängung / Track Control Arm ALL TYPES	▲ ↻ ↑	21199 51460-SP0-033
			
	Lenker, Radaufhängung / Track Control Arm ALL TYPES	▲ ↻ ↑	21200 51450-SP0-033
			
	Faltenbalgsatz, Lenkung / Bellow Kit, steering system ALL TYPES	↔	30139 53534-SB4-951
		↔	

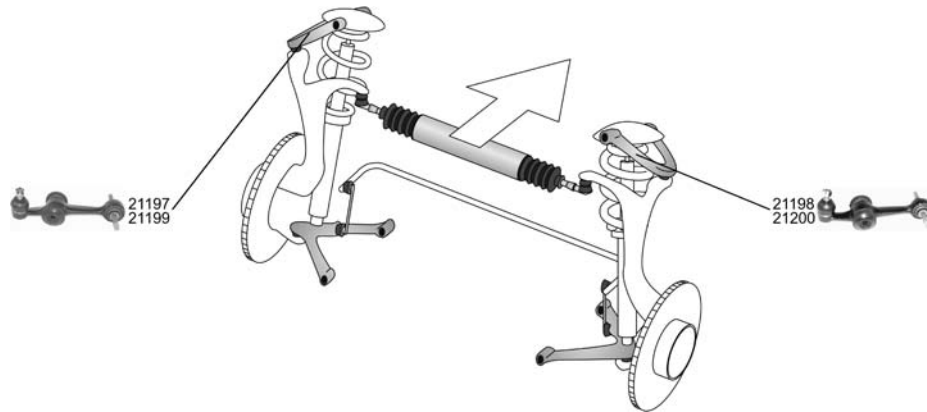
LEGEND II Coupe (KA8)

01.91 - 02.96



Lenker, Radaufhängung / Track Control Arm ALL TYPES	▲ ↻ ↓	21197 52400-SP0-013
		
Lenker, Radaufhängung / Track Control Arm ALL TYPES	▲ ↻ ↓	21198 52390-SP0-013
		
Lenker, Radaufhängung / Track Control Arm ALL TYPES	▲ ↻ ↑	21199 51460-SP0-033
		
Lenker, Radaufhängung / Track Control Arm ALL TYPES	▲ ↻ ↑	21200 51450-SP0-033
		
Faltenbalgsatz, Lenkung / Bellow Kit, steering system ALL TYPES	↔	30139 53534-SB4-951
	↔	







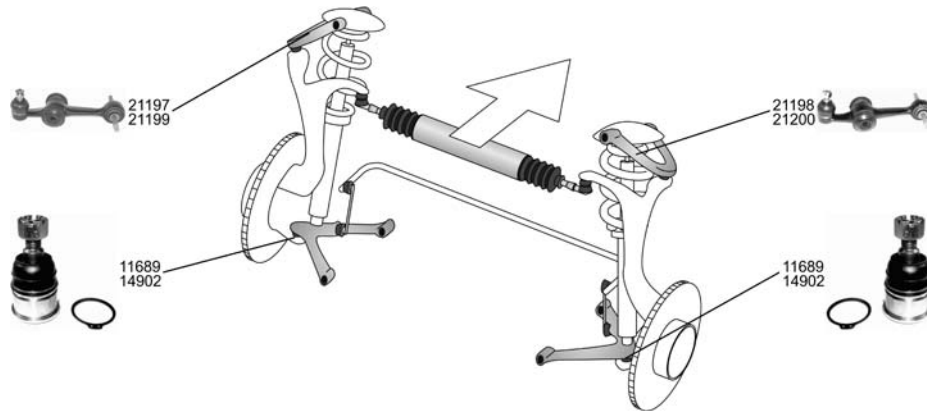

OE

HONDA

LEGEND III (KA9)

02.96 -





Lenker, Radaufhängung / Track Control Arm ALL TYPES	▲ ↻ ↓	21197 52400-SP0-013 
Lenker, Radaufhängung / Track Control Arm ALL TYPES	▲ ↻ ↓	21198 52390-SP0-013 
Lenker, Radaufhängung / Track Control Arm ALL TYPES	▲ ↻ ↑	21199 51460-SP0-033 
Lenker, Radaufhängung / Track Control Arm ALL TYPES	▲ ↻ ↑	21200 51450-SP0-033 
Trag-/Führungsgelenk / Support-/ Steering Link ALL TYPES	▽ ↻ ♂	11689 51220-SD4-023 
Trag-/Führungsgelenk / Support-/ Steering Link ALL TYPES	▽ ↻ ♂	14902 51220-S84-A02 

PRELUDE II (AB)

11.83 - 04.87







Spurstangenkopf / Tie-rod End Innengewinde [mm] / Inner Thread [mm]:M12x1,25 Gewindeart: mit Rechtsgewinde / Thread Type: with right-hand thread 1.8 EX 11.83 - 04.87	↻ ♂	11700 53540-SC2-004 
Axialgelenk, Spurstange / Axial Rod, tie rod Gewindeart: mit Rechtsgewinde / Thread Type: with right-hand thread Gewindemaß / Thread Size:M12x1,25 1.8 EX 11.83 - 04.87	▲ ↻ ↻	15435 53521-SF1-003 



HONDA

PRELUDE II (AB)





11.83 - 04.87

 Trag-/Führungsgelenk / Support-/ Steering Link 1.8 EX	11.83 - 04.87	▼↔	11688 51220-SK7-013 
Trag-/Führungsgelenk / Support-/ Steering Link 1.8 EX	11.83 - 04.87	▲↔♂	15425 51270-SB0-013 
Faltenbalgsatz, Lenkung / Bellow Kit, steering system 1.8 EX	11.83 - 04.87	↔ 	30139 53534-SB4-951 

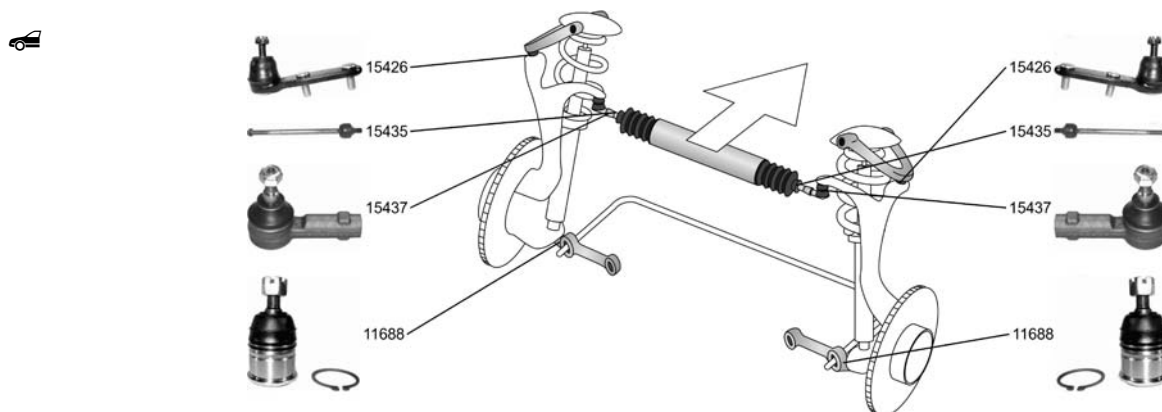
PRELUDE III (BA)

04.86 - 01.92







Spurstangenkopf / Tie-rod End Gewindeart: mit Rechtsgewinde / Thread Type: with right-hand thread Gewindemaß / Thread Size:M14x1,5 ALL TYPES		↔	15437 53540-SF1-004 
Axialgelenk, Spurstange / Axial Rod, tie rod Gewindeart: mit Rechtsgewinde / Thread Type: with right-hand thread Gewindemaß / Thread Size:M12x1,25 ALL TYPES		▲↔♂	15435 53521-SF1-003 
Trag-/Führungsgelenk / Support-/ Steering Link ALL TYPES		▼↔	11688 51220-SK7-013 
Trag-/Führungsgelenk / Support-/ Steering Link ALL TYPES		▲↔♂	15426 51270-SF1-003 
Faltenbalgsatz, Lenkung / Bellow Kit, steering system ALL TYPES		↔	30139 53534-SB4-951 
		↔	



OE





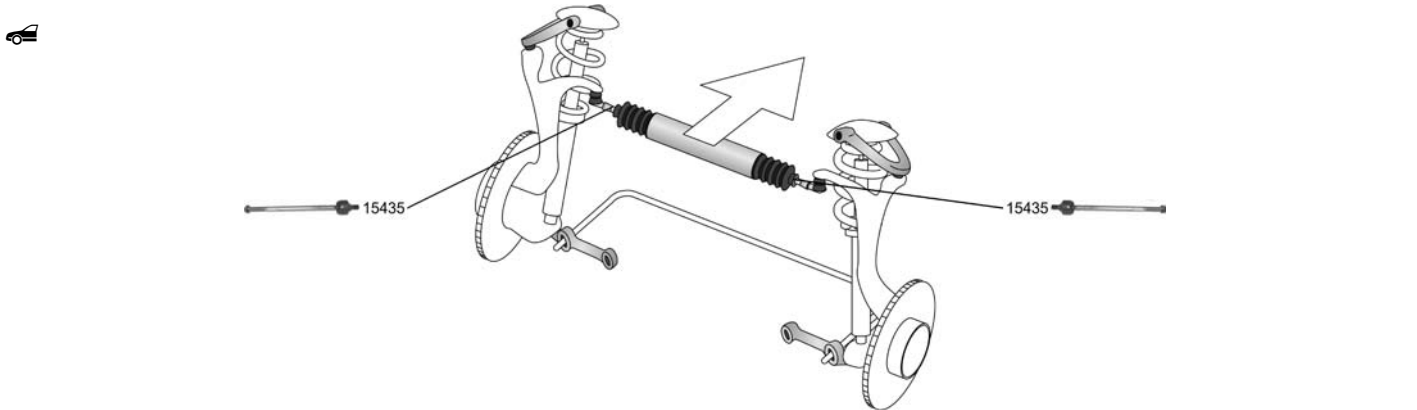

HONDA

PRELUDE IV (BB) 02.92 - 09.96

 Faltenbalgsatz, Lenkung / Bellow Kit, steering system ALL TYPES		30139 53534-SB4-951 
		







PRELUDE V (BB) 10.96 -

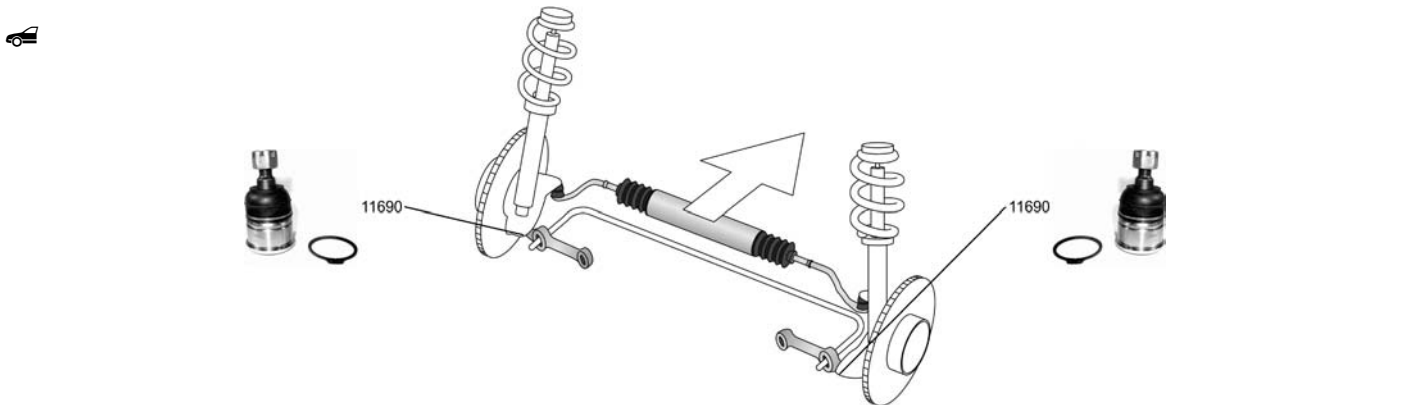

Axialgelenk, Spurstange / Axial Rod, tie rod Gewindeart: mit Rechtsgewinde / Thread Type: with right-hand thread Gewindemaß / Thread Size:M12x1,25 ALL TYPES		15435 53521-SF1-003 
		
Faltenbalgsatz, Lenkung / Bellow Kit, steering system ALL TYPES		30147 53534-SV4-N01 
		

SHUTTLE (RA) 10.94 - 05.01



Trag-/Führungsgelenk / Support-/ Steering Link ALL TYPES		11690 51220-SM4-013 
		
Faltenbalgsatz, Lenkung / Bellow Kit, steering system ALL TYPES		30147 53534-SV4-N01 
		



HONDA

Arithmetische Liste / Part number list

Artikelnummer Article No.	Seite Page	Hersteller Manufacturer	Artikelnummer Article No.	Seite Page	Hersteller Manufacturer
11688 ▽⊕	1 2 16	HONDA	15430 ▲⊕	16 17 18	HONDA
Trag-/Führungsgelenk / Support-/ Steering Link	17 19 32 38		Lenker, Radaufhängung / Track Control Arm	32	
11689 ▽⊕♂	34 35 37	HONDA	15431 ▲⊕	16 17 18	HONDA
Trag-/Führungsgelenk / Support-/ Steering Link			Lenker, Radaufhängung / Track Control Arm	32	
11690 ▽⊕	5 6 7	HONDA	15435 ▲⊕♂	37 38 39	HONDA
Trag-/Führungsgelenk / Support-/ Steering Link	8 9 10 11 12 39		Axialgelenk, Spurstange / Axial Rod, tie rod		
11693 ▲▽⊕	14 15 31	HONDA	15436 ⊕♂	3 4 5	HONDA
Lenker, Radaufhängung / Track Control Arm			Axialgelenk, Spurstange / Axial Rod, tie rod	8	
11695 ▲▽⊕	1 2	HONDA	15437 ⊕	38	HONDA
Lenker, Radaufhängung / Track Control Arm			Spurstangenkopf / Tie-rod End		
11696 ▲▲⊕	1 2	HONDA	15438 ⊕♂	16 17 18	HONDA
Lenker, Radaufhängung / Track Control Arm			Spurstangenkopf / Tie-rod End	19 20 21 23 31 33	
11697 ▲▽⊕	1 2	HONDA	15439 ⊕♂	3 4 5	HONDA
Lenker, Radaufhängung / Track Control Arm			Spurstangenkopf / Tie-rod End	6 7 8 9 10 11 12	
11698 ⊕♂	19 21 22	HONDA	15440 ⊕♂	16 17 18	HONDA
Axialgelenk, Spurstange / Axial Rod, tie rod	23 24 27 33		Spurstangenkopf / Tie-rod End	19 21 22 23 32 33	
11699 ▲⊕	16 17 18	HONDA	15441 ⊕♂	3 4 5	HONDA
Axialgelenk, Spurstange / Axial Rod, tie rod	20 22 23 24 25 26 27 32 33		Spurstangenkopf / Tie-rod End	6 7 8 9 10 11 12	
11700 ⊕♂	1 2 14	HONDA	19740 ⊕♂	29 30	HONDA
Spurstangenkopf / Tie-rod End	15 31 34 37		Spurstangenkopf / Tie-rod End		
14902 ▽⊕♂	3 4 37	HONDA	21197 ▲⊕Ⓡ	35 36 37	HONDA
Trag-/Führungsgelenk / Support-/ Steering Link			Lenker, Radaufhängung / Track Control Arm		
14933 ⊕♂	1 2	HONDA	21198 ▲⊕Ⓡ	35 36 37	HONDA
Axialgelenk, Spurstange / Axial Rod, tie rod			Lenker, Radaufhängung / Track Control Arm		
14935 ⊕♂	14 15 31	HONDA	21199 ▲⊕Ⓡ	36 37	HONDA
Axialgelenk, Spurstange / Axial Rod, tie rod	34		Lenker, Radaufhängung / Track Control Arm		
15200 ⊕♂	34 35	HONDA	21200 ▲⊕Ⓡ	36 37	HONDA
Spurstangenkopf / Tie-rod End			Lenker, Radaufhängung / Track Control Arm		
15201 ⊕♂	34 35	HONDA	22688 ▽⊕	20 21 22	HONDA
Spurstangenkopf / Tie-rod End			Trag-/Führungsgelenk / Support-/ Steering Link	23 32	
15425 ▲⊕♂	38	HONDA	22689 ▽⊕	33	HONDA
Trag-/Führungsgelenk / Support-/ Steering Link			Trag-/Führungsgelenk / Support-/ Steering Link		
15426 ▲⊕♂	38	HONDA	22690 ⊕	24 25 26	HONDA
Trag-/Führungsgelenk / Support-/ Steering Link			Stange/Strebe, Stabilisator / Rod/Strut, stabiliser	27	
			22862 ▲▲⊕	3	HONDA
			Lenker, Radaufhängung / Track Control Arm		

Artikelnummer Article No.	Seite Page	Hersteller Manufacturer	Artikelnummer Article No.	Seite Page	Hersteller Manufacturer
22863 ▲▲⊕	3	HONDA	30147 ⊕	3 4 6	HONDA
Lenker, Radaufhängung / Track Control Arm			Faltenbalgsatz, Lenkung / Bellow Kit, steering system	7 19 20 21 22 23 39	
24699 ▲▲⊕	7	HONDA	30221 ⊕	9 10 11	HONDA
Lenker, Radaufhängung / Track Control Arm			Faltenbalgsatz, Lenkung / Bellow Kit, steering system	12	
24702 ▽⊕	20 23	HONDA	30234 ⊕	7 8 11	HONDA
Lenker, Radaufhängung / Track Control Arm			Faltenbalgsatz, Lenkung / Bellow Kit, steering system		
24703 ▽⊕	20 23	HONDA			
Lenker, Radaufhängung / Track Control Arm					
24708 ▲⊕	20 21 22 24 25 26 27	HONDA			
Lenker, Radaufhängung / Track Control Arm					
24709 ▲⊕	20 21 22 24 25 26 27	HONDA			
Lenker, Radaufhängung / Track Control Arm					
24710 ▲▲⊕	7	HONDA			
Lenker, Radaufhängung / Track Control Arm					
29641 ⊕	24 25 26 27	HONDA			
Stange/Strebe, Stabilisator / Rod/Strut, stabiliser					
29654 ⊕	28 29	HONDA			
Stange/Strebe, Stabilisator / Rod/Strut, stabiliser					
29655 ⊕	28 29	HONDA			
Stange/Strebe, Stabilisator / Rod/Strut, stabiliser					
29656 ⊕	13	HONDA			
Spurstangenkopf / Tie-rod End					
29657 ⊕	13	HONDA			
Spurstangenkopf / Tie-rod End					
29795 ⊕	9 10 11 12	HONDA			
Stange/Strebe, Stabilisator / Rod/Strut, stabiliser					
29796 ⊕	9 10 11 12	HONDA			
Stange/Strebe, Stabilisator / Rod/Strut, stabiliser					
29798 ⊕	28 29 30	HONDA			
Spurstangenkopf / Tie-rod End					
29991 ▲(x2)	29 30	HONDA			
Achskörperlager / Mounting, axle body					
30138 ⊕	14 15 19	HONDA			
Faltenbalgsatz, Lenkung / Bellow Kit, steering system					
30139 ⊕	1 2 3 5 15 16 17 18 19 31 32 33 34 35 36	HONDA			
Faltenbalgsatz, Lenkung / Bellow Kit, steering system					

Vergleichsliste / Cross reference list

Vergleichs-Nr. Compare No.	Artikelnummer Article No.	Vergleichs-Nr. Compare No.	Artikelnummer Article No.	Vergleichs-Nr. Compare No.	Artikelnummer Article No.
HONDA					
51220-S84-A02	14902				
51220-SD4-023	11689				
51220-SK7-013	11688				
51220-SM4-013	11690				
51220-SR3-003	22688				
51220-SR3-013	22689				
51270-SB0-013	15425				
51270-SF1-003	15426				
51320-S04-003	29641				
51320-S5A-003	29654				
51320-S84-A01	29796				
51320-ST7-003	22690				
51321-S5A-003	29655				
51321-S84-A01	29795				
51350-SR3-010	24702				
51351-SD2-003	11693				
51360-SR3-010	24703				
51450-SH3-030	15430				
51450-SM1-A03	22863				
51450-SP0-033	21200				
51450-SV4-000	24710				
51459-SE0-003	11695				
51460-SH3-030	15431				
51460-SM1-A03	22862				
51460-SP0-033	21199				
51460-SV4-000	24699				
51469-SE0-003	11696				
52390-SE0-043	11697				
52390-SP0-013	21198				
52390-SR3-000	24708				
52400-SP0-013	21197				
52400-SR3-000	24709				
53010-SR3-010	11698				
53521-SB2-013	14935				
53521-SE0-951	14933				
53521-SF1-003	15435				
53521-SH3-003	11699				
53521-SM4-013	15436				
53534-634-020	30138				
53534-S84-A01	30234				
53534-SB4-951	30139				
53534-SV4-N01	30147				
53536-S1A-E01	30221				
53540-SC2-004	11700				
53540-SD4-003	15200				
53540-SDA-A01	29656				
53540-SF1-004	15437				
53540-SK3-E01	19740				
53540-SM4-004	15439				
53540-SR3-003	15438				
53541-S5A-003	29798				
53560-SD4-003	15201				
53560-SDA-A01	29657				
53560-SM4-004	15441				
53560-SR3-003	15440				

Neuaufnahmen / New to range

Artikelnummer Article No.	Seite Page	Hersteller Manufacturer
11688	1 2 16 17 19 32 38	HONDA
11698	19 21 22 23 24 27 33	HONDA
15200	34 35	HONDA
15201	34 35	HONDA
15425	38	HONDA
19740	29 30	HONDA
21197	35 36 37	HONDA
21198	35 36 37	HONDA
21199	36 37	HONDA
21200	36 37	HONDA
22688	20 21 22 23 32	HONDA
22689	33	HONDA
22690	24 25 26 27	HONDA
24702	20 23	HONDA
24703	20 23	HONDA
24708	20 21 22 24 25 26 27	HONDA
24709	20 21 22 24 25 26 27	HONDA
29641	24 25 26 27	HONDA
29654	28 29	HONDA
29655	28 29	HONDA
29656	13	HONDA
29657	13	HONDA
29795	9 10 11 12	HONDA
29796	9 10 11 12	HONDA
29798	28 29 30	HONDA
30138	14 15 19	HONDA
30139	1 2 3 5 15 16 17 18 19 31 32 33 34 35 36 38 39	HONDA
30147	3 4 6 7 19 20 21 22 23 39	HONDA
30221	9 10 11 12	HONDA
30234	7 8 11	HONDA

Artikelnummer Article No.	Seite Page	Hersteller Manufacturer
------------------------------	---------------	----------------------------

Geänderte Bestellnummer / Amended part numbers

Artikelnummer alt Article No. old	Artikelnummer neu Article No. new	Artikelnummer alt Article No. old	Artikelnummer neu Article No. new	Artikelnummer alt Article No. old	Artikelnummer neu Article No. new
14903	15430				
15442	30138				
15443	30139				
15585	30147				
22867	15440				

Geänderte Bestellnummer / Amended part numbers

Artikelnummer neu Article No. new	Artikelnummer alt Article No. old	Artikelnummer neu Article No. new	Artikelnummer alt Article No. old	Artikelnummer neu Article No. new	Artikelnummer alt Article No. old
15430	14903				
15440	22867				
30138	15442				
30139	15443				
30147	15585				

© ZF Trading GmbH - 14.10.06