



OE

# HYUNDAI

ACCENT (X-3)

10.94 - 01.00

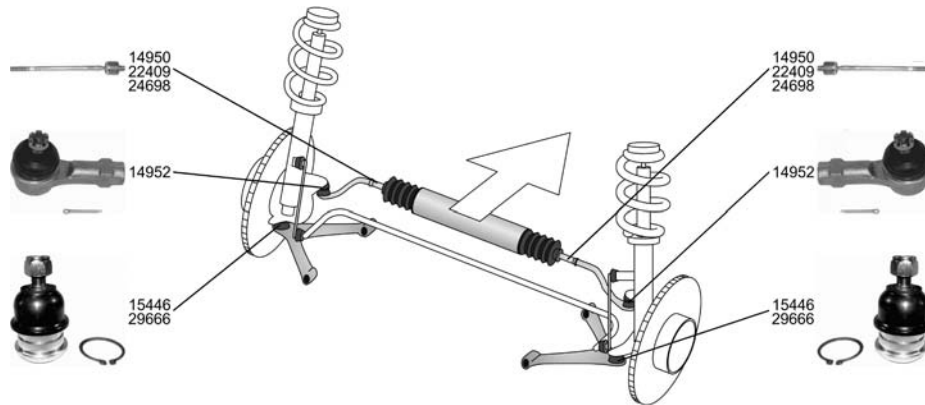

<p><b>Spurstangenkopf / Tie-rod End</b> Gewindeart: mit Rechtsgewinde / Thread Type: with right-hand thread ALL TYPES</p>		<p><b>14952</b>      56820-28500</p>
<p><b>Axialgelenk, Spurstange / Axial Rod, tie rod</b> ALL TYPES</p>		<p><b>14950</b>      56540-24001</p>
<p><b>Axialgelenk, Spurstange / Axial Rod, tie rod</b> ALL TYPES</p>		<p><b>22409</b>      57730-43010</p>
<p><b>Axialgelenk, Spurstange / Axial Rod, tie rod</b> ALL TYPES</p>		<p><b>24698</b>      57755-22000</p>
<p><b>Trag-/Führungsgelenk / Support-/ Steering Link</b> ALL TYPES</p>		<p><b>15446</b>      54503-25A00</p>
<p><b>Trag-/Führungsgelenk / Support-/ Steering Link</b> ALL TYPES</p>		<p><b>29666</b>      54503-25A00</p>



# HYUNDAI

ACCENT Stufenheck/Saloon/avec coffre (X-3)

10.94 - 01.00

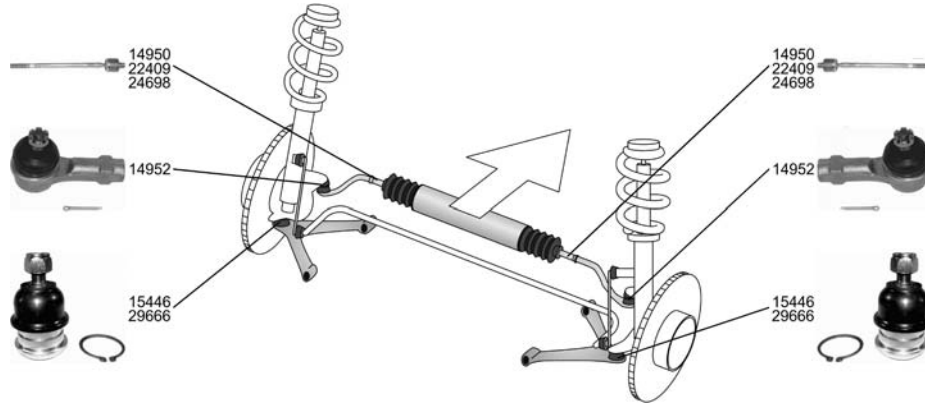

<p><b>Spurstangenkopf / Tie-rod End</b> Gewindeart: mit Rechtsgewinde / Thread Type: with right-hand thread ALL TYPES</p>		<p><b>14952</b>      56820-28500</p>
<p><b>Axialgelenk, Spurstange / Axial Rod, tie rod</b> ALL TYPES</p>		<p><b>14950</b>      56540-24001</p>
<p><b>Axialgelenk, Spurstange / Axial Rod, tie rod</b> ALL TYPES</p>		<p><b>22409</b>      57730-43010</p>
<p><b>Axialgelenk, Spurstange / Axial Rod, tie rod</b> ALL TYPES</p>		<p><b>24698</b>      57755-22000</p>
<p><b>Trag-/Führungsgelenk / Support-/ Steering Link</b> ALL TYPES</p>		<p><b>15446</b>      54503-25A00</p>
<p><b>Trag-/Führungsgelenk / Support-/ Steering Link</b> ALL TYPES</p>		<p><b>29666</b>      54503-25A00</p>





OE

# HYUNDAI

## ACCENT (LC)

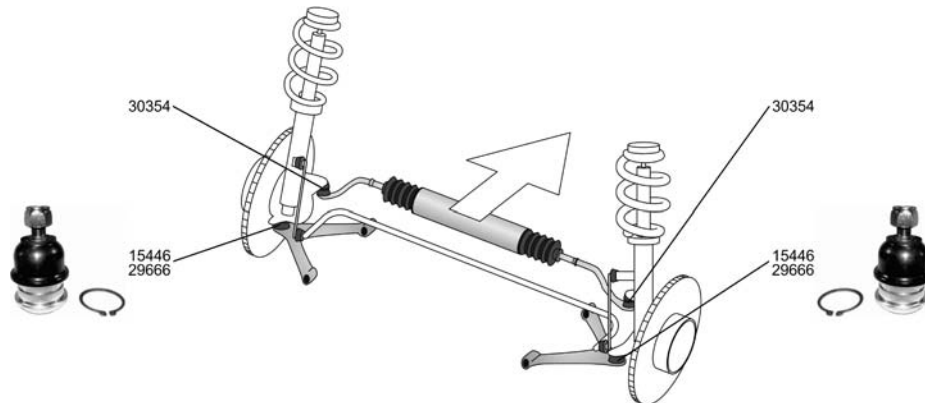
01.00 -



<b>Spurstangenkopf / Tie-rod End</b>		<b>30354</b>	<b>56820-25000</b>
ALL TYPES ausser/except for :			
1.5 CRDi	04.02 -		
1.6	12.02 -		
<b>Trag-/Führungsgelenk / Support-/ Steering Link</b>		<b>15446</b>	<b>54503-25A00</b>
1.3, 55 kW	01.00 -		
1.3, 63 kW	01.00 -		
1.5, 75 kW	09.00 -		
<b>Trag-/Führungsgelenk / Support-/ Steering Link</b>		<b>29666</b>	<b>54503-25A00</b>
1.3, 55 kW	01.00 -		
1.3, 63 kW	01.00 -		
1.5, 75 kW	09.00 -		

## ACCENT Stufenheck/Saloon/avec coffre (LC)

01.00 -

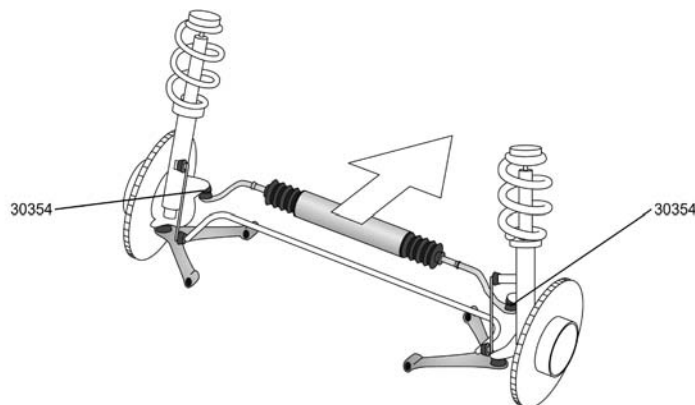

<b>Spurstangenkopf / Tie-rod End</b>		<b>30354</b>	<b>56820-25000</b>
1.3	01.00 -		
1.5	01.00 -		

## ATOS (MX)

02.98 -



<b>Spurstangenkopf / Tie-rod End</b>		<b>29662</b>	<b>56820-02500</b>
ALL TYPES			
<b>Trag-/Führungsgelenk / Support-/ Steering Link</b>		<b>30358</b>	<b>54530-02050</b>
ALL TYPES			

## ATOS PRIME (MX)

08.99 -



<b>Spurstangenkopf / Tie-rod End</b>		<b>29662</b>	<b>56820-02500</b>
1.0 i	08.99 -		



# HYUNDAI

## ATOS PRIME (MX)









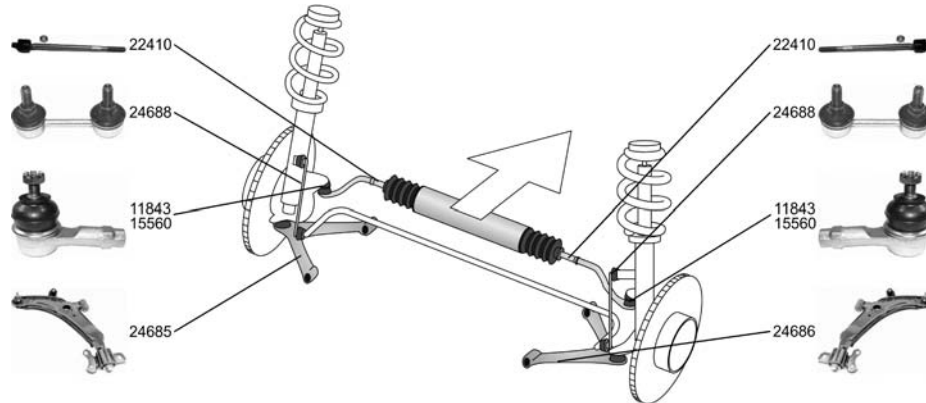





08.99 -

	<b>Trag-/Führungsgelenk / Support-/ Steering Link</b> ALL TYPES		<b>30358</b>	54530-02050
---	--	---	--------------	-------------

## COUPE (RD)

06.96 - 04.02



<b>Spurstangenkopf / Tie-rod End</b> Gewindeart: mit Rechtsgewinde / Thread Type: with right-hand thread Innengewinde [mm] / Inner Thread [mm]:M12x1,25		<b>11843</b> <b>56820-28000</b>
1.6 16V 2.0 16V, 102 kW	03.98 - 04.02 08.96 - 04.02	
<b>Spurstangenkopf / Tie-rod End</b> Gewindeart: mit Rechtsgewinde / Thread Type: with right-hand thread Innengewinde [mm] / Inner Thread [mm]:M12x1,25		<b>15560</b>
1.6 16V 2.0 16V, 102 kW	03.98 - 04.02 08.96 - 04.02	
<b>Axialgelenk, Spurstange / Axial Rod, tie rod</b>		<b>22410</b> <b>57730-29000</b>
1.6 i 16V 1.6 16V 2.0 16V, 102 kW	12.96 - 04.02 03.98 - 04.02 08.96 - 04.02	
<b>Lenker, Radaufhängung / Track Control Arm</b> ohne Zubehör / without accessories ALL TYPES		<b>24685</b> <b>54500-29000</b>
		
<b>Lenker, Radaufhängung / Track Control Arm</b> ohne Zubehör / without accessories ALL TYPES		<b>24686</b> <b>54501-29000</b>
		
<b>Stange/Strebe, Stabilisator / Rod/Strut, stabiliser</b> Pendelstange / Suspension Rod		<b>24688</b> <b>54830-29000</b>
1.6 i 16V 1.6 16V 2.0 16V, 102 kW	12.96 - 04.02 03.98 - 04.02 08.96 - 04.02	
<b>Faltenbalgsatz, Lenkung / Bellow Kit, steering system</b> ALL TYPES	 	<b>30138</b>
		







OE

# HYUNDAI

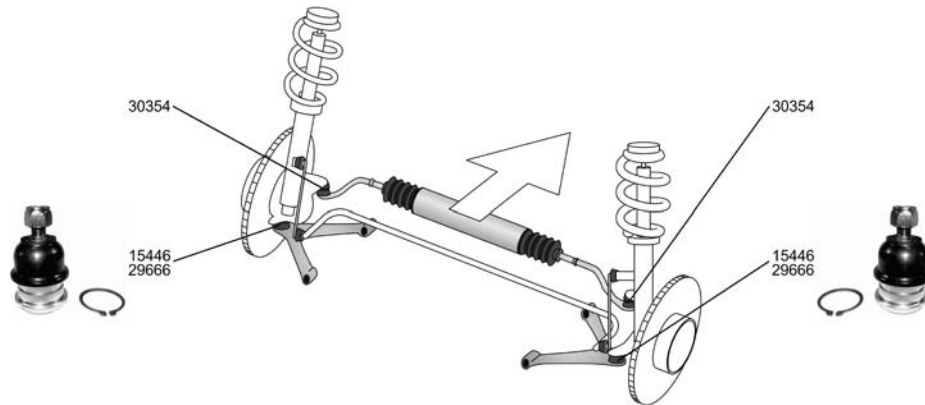
## ELANTRA (XD)

06.00 -





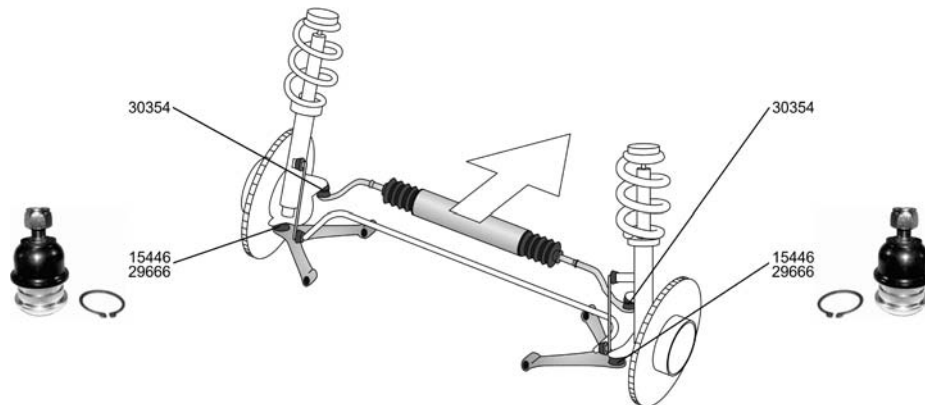

<b>Spurstangenkopf / Tie-rod End</b>		<b>30354</b>	<b>56820-25000</b>
ALL TYPES			
<b>Trag-/Führungsgelenk / Support-/ Steering Link</b>		<b>15446</b>	<b>54503-25A00</b>
ALL TYPES ausser/except for :			
1.6, 77 kW	05.03 -		
2.0, 105 kW	10.03 -		
<b>Trag-/Führungsgelenk / Support-/ Steering Link</b>		<b>29666</b>	<b>54503-25A00</b>
ALL TYPES ausser/except for :			
1.6, 77 kW	05.03 -		
2.0, 105 kW	10.03 -		

## ELANTRA Stufenheck/Saloon/avec coffre (XD)

06.00 -



<b>Spurstangenkopf / Tie-rod End</b>		<b>30354</b>	<b>56820-25000</b>
ALL TYPES ausser/except for :			
1.8, 94 kW	06.00 -		
<b>Trag-/Führungsgelenk / Support-/ Steering Link</b>		<b>15446</b>	<b>54503-25A00</b>
1.6, 79 kW	06.00 -		
1.8, 97 kW	06.00 -		
2.0, 102 kW	06.00 -		
2.0 CRDi	04.01 -		
<b>Trag-/Führungsgelenk / Support-/ Steering Link</b>		<b>29666</b>	<b>54503-25A00</b>
1.6, 79 kW	06.00 -		
1.8, 97 kW	06.00 -		
2.0, 102 kW	06.00 -		
2.0 CRDi	04.01 -		











OE

# HYUNDAI

GETZ (TB)



09.02 -

	<b>Spurstangenkopf / Tie-rod End</b> ALL TYPES		<b>30357</b>	<b>56820-3B000</b>
	<b>Trag-/Führungsgelenk / Support-/ Steering Link</b> ALL TYPES	   	<b>15446</b>	<b>54503-25A00</b>
				
	<b>Trag-/Führungsgelenk / Support-/ Steering Link</b> ALL TYPES	 	<b>29666</b>	<b>54503-25A00</b>

H100 Bus/Familial (P)

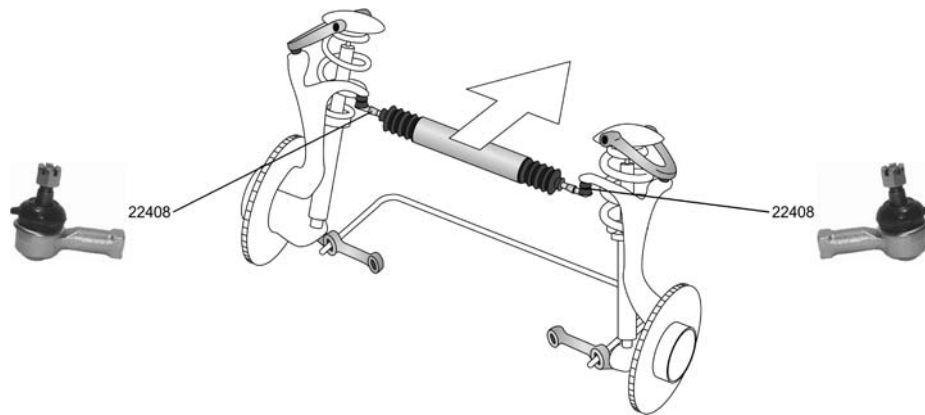
07.93 -





<b>Spurstangenkopf / Tie-rod End</b>	 	<b>22408</b>	<b>56872-43000</b>
2.4 2.5 D	07.93 - 03.00 07.93 - 03.00		

H100 Kasten/Box/Furgón/Panel Van

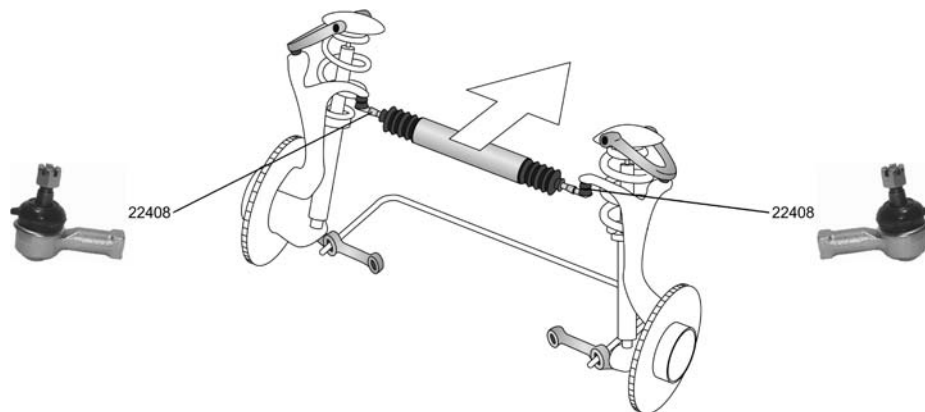
07.93 -



<b>Spurstangenkopf / Tie-rod End</b>	 	<b>22408</b>	<b>56872-43000</b>
ALL TYPES			



OE

# HYUNDAI

## STAREX (H1)

06.97 -

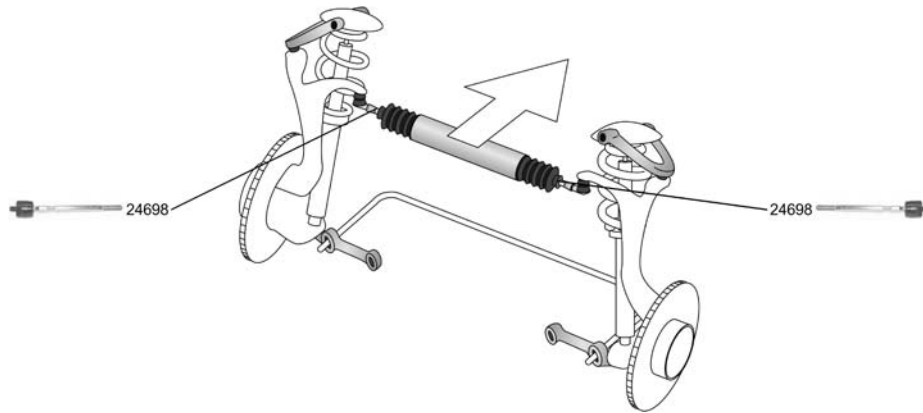

<b>Axialgelenk, Spurstange / Axial Rod, tie rod</b>		<b>24698</b> 57755-22000
ALL TYPES		

## H-1 Starex/Bus/Familial

10.97 -

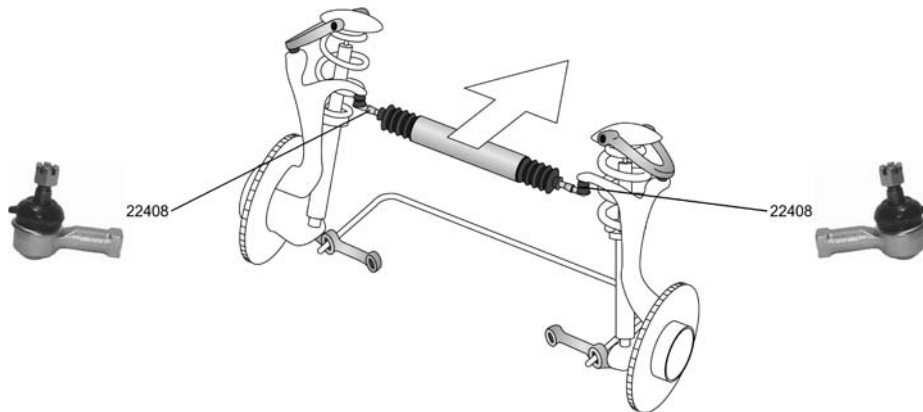

<b>Spurstangenkopf / Tie-rod End</b>		<b>22408</b> 56872-43000
2.4 2.5 TD, 59 kW 2.5 TD, 73 kW	10.97 - 10.97 - 10.99 - 11.01	









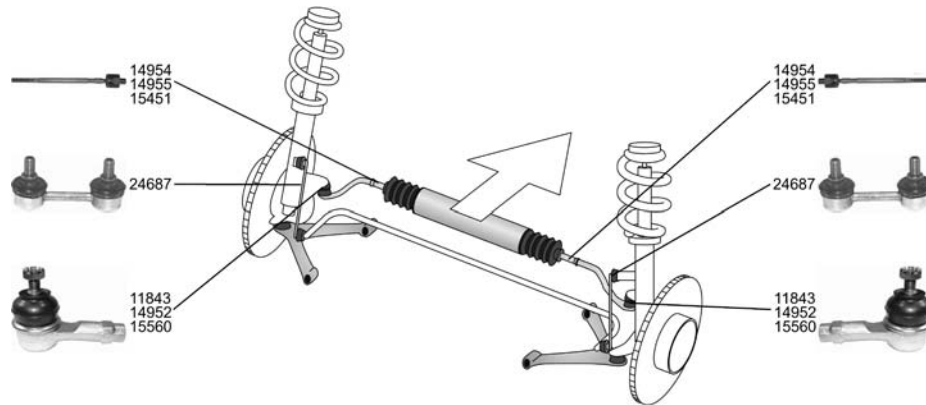







# HYUNDAI

## LANTRA I (J-1)

10.90 - 11.95



<b>Spurstangenkopf / Tie-rod End</b> Gewindeart: mit Rechtsgewinde / Thread Type: with right-hand thread Innengewinde [mm] / Inner Thread [mm]:M12x1,25 ALL TYPES		<b>11843</b> 56820-28000 
<b>Spurstangenkopf / Tie-rod End</b> Gewindeart: mit Rechtsgewinde / Thread Type: with right-hand thread ALL TYPES		<b>14952</b> 56820-28500 
<b>Spurstangenkopf / Tie-rod End</b> Gewindeart: mit Rechtsgewinde / Thread Type: with right-hand thread Innengewinde [mm] / Inner Thread [mm]:M12x1,25 ALL TYPES		<b>15560</b> 
<b>Axialgelenk, Spurstange / Axial Rod, tie rod</b> ALL TYPES		<b>14954</b> 57730-28000 
<b>Axialgelenk, Spurstange / Axial Rod, tie rod</b> ALL TYPES		<b>14955</b> 57730-28500 
<b>Axialgelenk, Spurstange / Axial Rod, tie rod</b> ALL TYPES		<b>15451</b> 57730-33100 
<b>Stange/Strebe, Stabilisator / Rod/Strut, stabiliser</b> Pendelstange / Suspension Rod ALL TYPES		<b>24687</b> 54830-37020 
<b>Faltenbalgsatz, Lenkung / Bellow Kit, steering system</b> 1.6 i.e. 16V      10.90 - 11.95 1.8 i.e. 16V      10.90 - 11.95		<b>30228</b> 56528-24000 











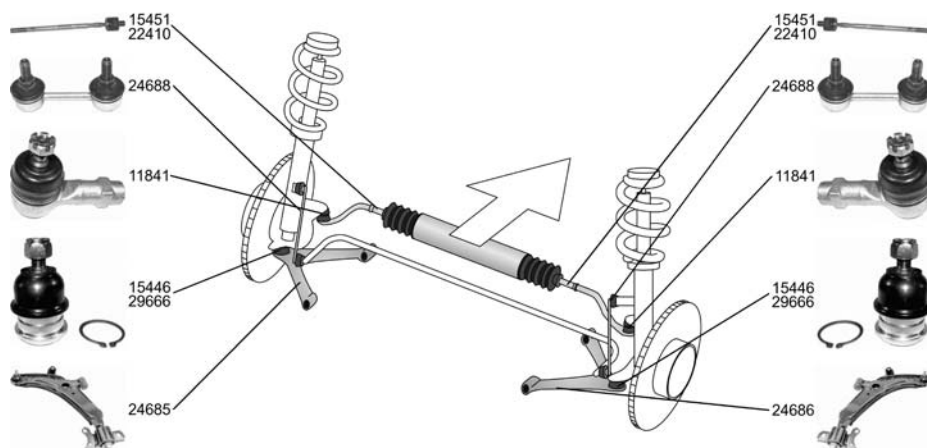

## HYUNDAI

### LANTRA II (J-2)

11.95 - 09.00

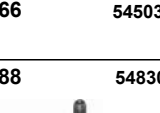

<b>Spurstangenkopf / Tie-rod End</b> Gewindeart: mit Rechtsgewinde / Thread Type: with right-hand thread Innengewinde [mm] / Inner Thread [mm]: M14x1,5 ALL TYPES			<b>11841</b> <b>56820-36000</b> 
<b>Axialgelenk, Spurstange / Axial Rod, tie rod</b> 1.6 i      11.95 - 09.00 1.6 16V      11.95 - 09.00 1.8 16V      11.95 - 09.00			<b>15451</b> <b>57730-33100</b> 
<b>Axialgelenk, Spurstange / Axial Rod, tie rod</b> ALL TYPES			<b>22410</b> <b>57730-29000</b> 
<b>Lenker, Radaufhängung / Track Control Arm</b> ohne Zubehör / without accessories ALL TYPES			<b>24685</b> <b>54500-29000</b> 
<b>Lenker, Radaufhängung / Track Control Arm</b> ohne Zubehör / without accessories ALL TYPES			<b>24686</b> <b>54501-29000</b> 
<b>Trag-/Führungsgelenk / Support-/ Steering Link</b> ALL TYPES			<b>15446</b> <b>54503-25A00</b> 
<b>Trag-/Führungsgelenk / Support-/ Steering Link</b> ALL TYPES			<b>29666</b> <b>54503-25A00</b> 
<b>Stange/Strebe, Stabilisator / Rod/Strut, stabiliser</b> Pendelstange / Suspension Rod ALL TYPES ausser/except for : 1.6 16V      11.95 - 09.00			<b>24688</b> <b>54830-29000</b> 



# HYUNDAI

## LANTRA II (J-2) 11.95 - 09.00

	<b>Faltenbaldsatz, Lenkung / Bellow Kit, steering system</b> ALL TYPES		<b>30228</b> 56528-24000	
	<b>Stange/Strebe, Stabilisator / Rod/Strut, stabiliser</b> Pendelstange / Suspension Rod ALL TYPES		<b>24689</b> 55530-29000	

## LANTRA II Wagon/Estate/Break (J2) 02.96 -

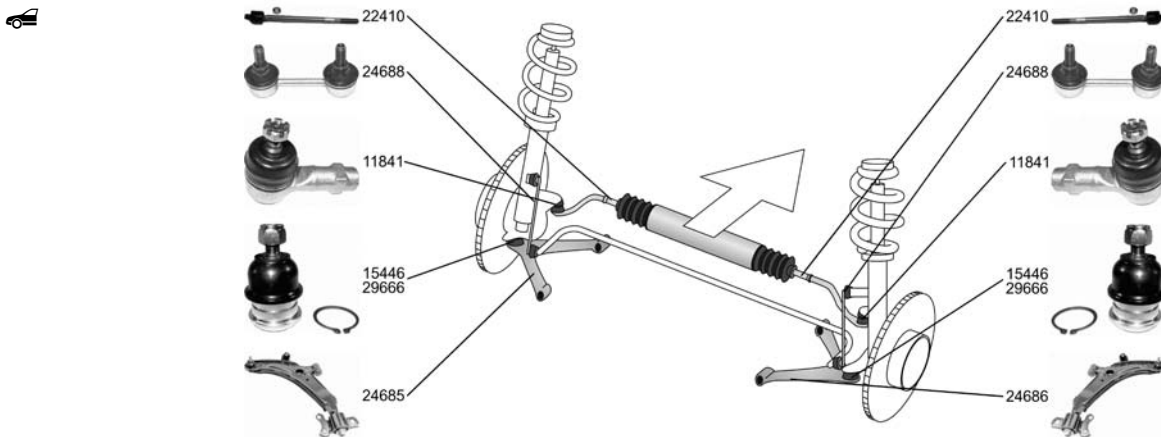



<b>Spurstangenkopf / Tie-rod End</b> Gewindeart: mit Rechtsgewinde / Thread Type: with right-hand thread Innengewinde [mm] / Inner Thread [mm]:M14x1,5 ALL TYPES		<b>11841</b> 56820-36000	
<b>Axialgelenk, Spurstange / Axial Rod, tie rod</b> ALL TYPES		<b>22410</b> 57730-29000	
<b>Lenker, Radaufhängung / Track Control Arm</b> ohne Zubehör / without accessories ALL TYPES		<b>24685</b> 54500-29000	
<b>Lenker, Radaufhängung / Track Control Arm</b> ohne Zubehör / without accessories ALL TYPES		<b>24686</b> 54501-29000	
<b>Trag-/Führungsgelenk / Support-/ Steering Link</b> 1.6 i 02.96 - 1.6 16V 02.96 - 1.8 16V 02.96 - 2.0 16V 12.96 -		<b>15446</b> 54503-25A00	



OE

# HYUNDAI

## LANTRA II Wagon/Estate/Break (J2) 02.96 -

	<b>Trag-/Führungsgelenk / Support-/ Steering Link</b>	▼↔	<b>29666</b>	<b>54503-25A00</b>
	1.6 i 1.6 16V 1.8 16V 2.0 16V	02.96 - 02.96 - 02.96 - 12.96 -		
	<b>Stange/Strebe, Stabilisator / Rod/Strut, stabiliser</b> Pendelstange / Suspension Rod ALL TYPES	↔	<b>24688</b>	<b>54830-29000</b>
	<b>Faltenbalgsatz, Lenkung / Bellow Kit, steering system</b> ALL TYPES		<b>30228</b>	<b>56528-24000</b>
	<b>Stange/Strebe, Stabilisator / Rod/Strut, stabiliser</b> Pendelstange / Suspension Rod ALL TYPES	↔	<b>24689</b>	<b>55530-29000</b>

## PONY 10.85 - 09.89

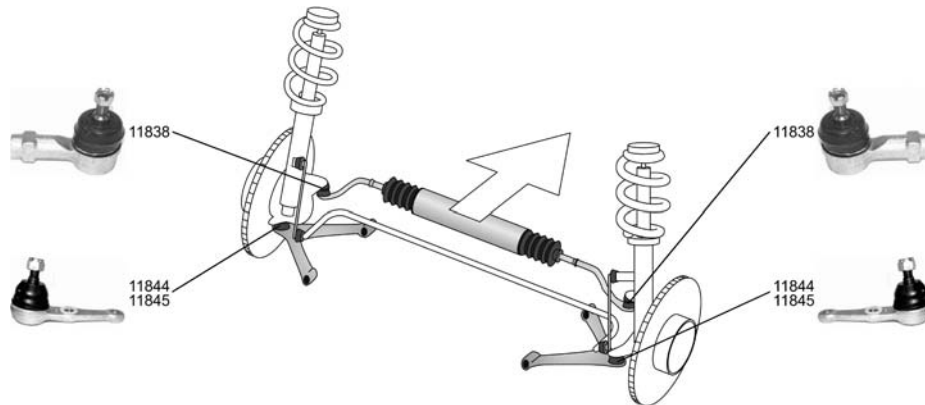







<b>Spurstangenkopf / Tie-rod End</b> Gewindemaß / Thread Size:M14x1,5 Gewindeart: mit Rechtsgewinde / Thread Type: with right-hand thread ALL TYPES	▲↔♂	<b>11838</b>
<b>Trag-/Führungsgelenk / Support-/ Steering Link</b> ALL TYPES	↔♂	<b>11844</b> <b>54530-21A00</b>
<b>Trag-/Führungsgelenk / Support-/ Steering Link</b> ALL TYPES	↔♂	<b>11845</b> <b>54540-21A00</b>



# HYUNDAI

**PONY Stufenheck/Saloon/avec coffre**







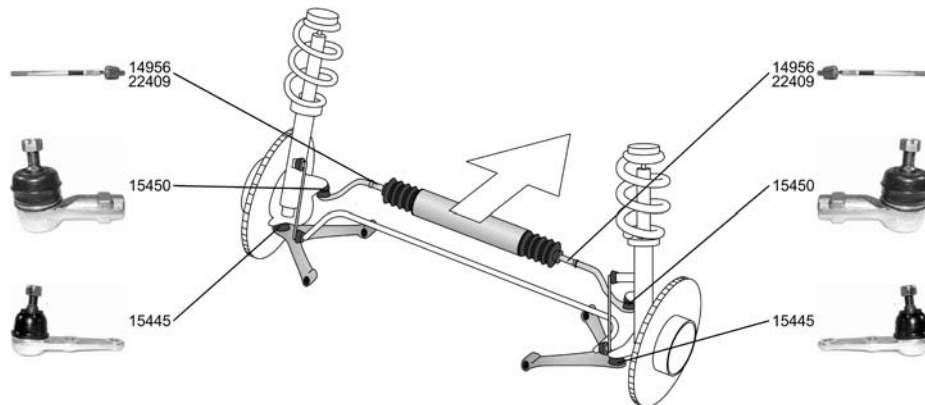

**10.85 - 09.89**

 <b>Spurstangenkopf / Tie-rod End</b> Gewindemaß / Thread Size:M14x1,5 Gewindeart: mit Rechtsgewinde / Thread Type: with right-hand thread ALL TYPES		<b>11838</b> 
<b>Trag-/Führungsgelenk / Support-/ Steering Link</b> ALL TYPES		<b>11844</b> <b>54530-21A00</b> 
<b>Trag-/Führungsgelenk / Support-/ Steering Link</b> ALL TYPES		<b>11845</b> <b>54540-21A00</b> 

# PONY (X-2)

**10.89 - 01.95**





<b>Spurstangenkopf / Tie-rod End</b> Gewindeart: mit Rechtsgewinde / Thread Type: with right-hand thread ALL TYPES		<b>15450</b> <b>56820-21100</b> 
<b>Axialgelenk, Spurstange / Axial Rod, tie rod</b> ALL TYPES		<b>14956</b> <b>57730-24000</b> 
<b>Axialgelenk, Spurstange / Axial Rod, tie rod</b> ALL TYPES		<b>22409</b> <b>57730-43010</b> 
<b>Trag-/Führungsgelenk / Support-/ Steering Link</b> mit Zubehör / With accessories ALL TYPES		<b>15445</b> <b>54530-24A00</b> 



OE









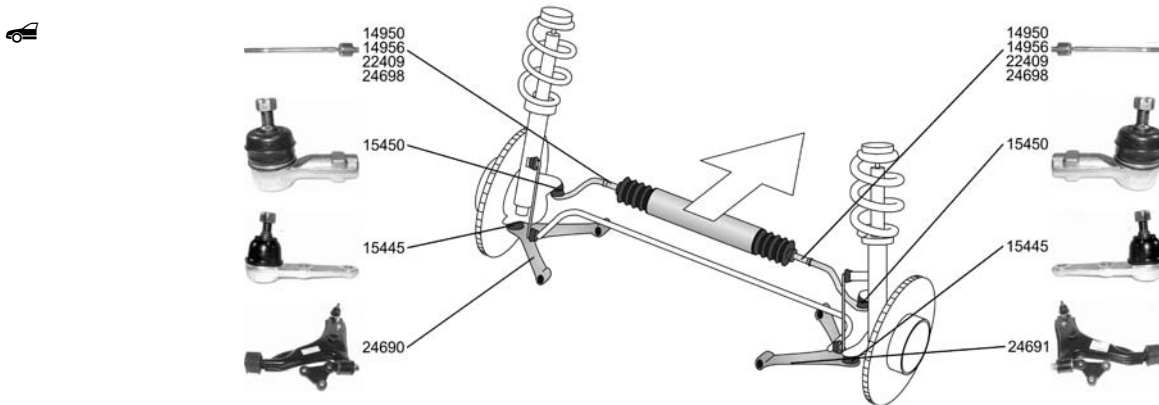







# HYUNDAI

## PONY (X-2) 10.89 - 01.95

	<b>Faltenbalgsatz, Lenkung / Bellow Kit, steering system</b>		<b>30138</b> 
	1.3, 43 kW	10.89 - 01.95	
	1.5	10.89 - 01.95	
	1.5 i	10.89 - 01.95	

## PONY, EXCEL Stufenheck/Saloon/avec coffre (X-2) 01.90 - 01.95









<b>Spurstangenkopf / Tie-rod End</b> Gewindeart: mit Rechtsgewinde / Thread Type: with right-hand thread ALL TYPES		<b>15450</b> 56820-21100 
<b>Axialgelenk, Spurstange / Axial Rod, tie rod</b> ALL TYPES	 	<b>14950</b> 56540-24001 
<b>Axialgelenk, Spurstange / Axial Rod, tie rod</b> ALL TYPES	  ->12.1992	<b>14956</b> 57730-24000 
<b>Axialgelenk, Spurstange / Axial Rod, tie rod</b> ALL TYPES	  01.1993->	<b>22409</b> 57730-43010 
<b>Axialgelenk, Spurstange / Axial Rod, tie rod</b> 1.5 01.90 - 01.95 1.5 i 01.90 - 01.95		<b>24698</b> 57755-22000 
<b>Lenker, Radaufhängung / Track Control Arm</b> 1.5 01.90 - 01.95 1.5 i 01.90 - 01.95		<b>24690</b> 54500-24000 
<b>Lenker, Radaufhängung / Track Control Arm</b> 1.5 01.90 - 01.95 1.5 i 01.90 - 01.95		<b>24691</b> 54501-24000 











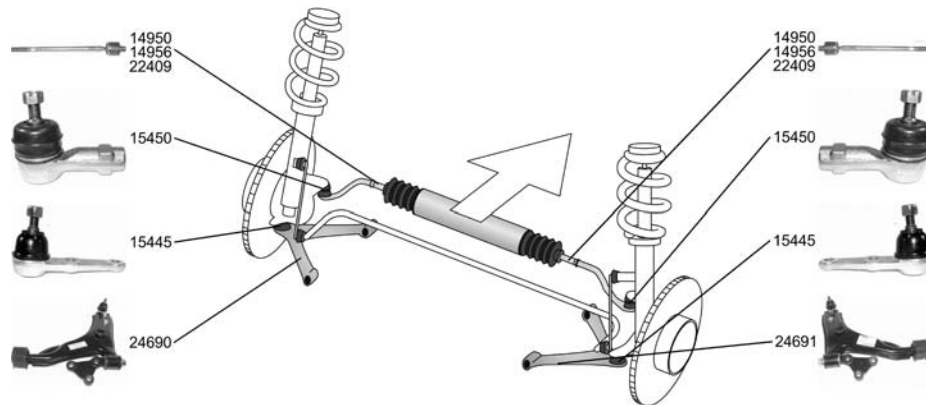







# HYUNDAI

## PONY, EXCEL 01.90 - 01.95 Stufenheck/Saloon/avec coffre (X-2)

 <b>Trag-/Führungsgelenk / Support-/ Steering Link</b> mit Zubehör / With accessories ALL TYPES		<b>15445</b> 54530-24A00 
<b>Faltenbalgsatz, Lenkung / Bellow Kit, steering system</b> 1.5 01.90 - 01.95 1.5 i 01.90 - 01.95	 	<b>30138</b> 

## S COUPE (SLC) 02.90 - 05.96











<b>Spurstangenkopf / Tie-rod End</b> Gewindeart: mit Rechtsgewinde / Thread Type: with right-hand thread 1.5 i 02.90 - 05.96 1.5 i Turbo 04.91 - 05.96	 	<b>15450</b> 56820-21100 
<b>Axialgelenk, Spurstange / Axial Rod, tie rod</b> 1.5 i 02.90 - 05.96 1.5 i Turbo 04.91 - 05.96	 	<b>14950</b> 56540-24001 
<b>Axialgelenk, Spurstange / Axial Rod, tie rod</b> 1.5 i 02.90 - 05.96 1.5 i Turbo 04.91 - 05.96	  ->06.1991	<b>14956</b> 57730-24000 
<b>Axialgelenk, Spurstange / Axial Rod, tie rod</b> 1.5 i, 62 kW 02.90 - 05.96 1.5 i Turbo 04.91 - 05.96 1.5 i, 65 kW 04.92 - 05.96	  07.1991-> 	<b>22409</b> 57730-43010 
<b>Lenker, Radaufhängung / Track Control Arm</b> 1.5 i 02.90 - 05.96 1.5 i Turbo 04.91 - 05.96		<b>24690</b> 54500-24000 







OE

# HYUNDAI

## S COUPE (SLC) 02.90 - 05.96

	<b>Lenker, Radaufhängung / Track Control Arm</b>		<b>24691</b>	<b>54501-24000</b>
	1.5 i 1.5 i Turbo	02.90 - 05.96 04.91 - 05.96		
	<b>Trag-/Führungsgelenk / Support-/ Steering Link mit Zubehör / With accessories</b>		<b>15445</b>	<b>54530-24A00</b>
	1.5 i 1.5 i Turbo	02.90 - 05.96 04.91 - 05.96		
	<b>Faltenbalgsatz, Lenkung / Bellow Kit, steering system</b>	 	<b>30138</b>	
	1.5 i 1.5 i Turbo	02.90 - 05.96 04.91 - 05.96		

## SANTA FÉ (SM) 02.01 -

	<b>Spurstangenkopf / Tie-rod End</b>		<b>30357</b>	<b>56820-3B000</b>	
	2.0 2.4 16V 2.4 16V 4x4 2.7 V6 4x4 2.0 CRDi 2.0 CRDi 4x4, 83 kW	08.01 - 02.01 - 02.01 - 02.01 - 08.01 - 04.01 -			
	<b>Trag-/Führungsgelenk / Support-/ Steering Link</b>		<b>30359</b>	<b>54503-3BA00</b>	
	2.0 2.4 16V 2.4 16V 4x4 2.7 V6 4x4 2.0 CRDi 2.0 CRDi 4x4, 83 kW	08.01 - 02.01 - 02.01 - 02.01 - 08.01 - 04.01 -			
	<b>Stange/Strebe, Stabilisator / Rod/Strut, stabiliser</b>		<b>30361</b>	<b>54840-26000</b>	
	2.0 2.4 16V 2.4 16V 4x4 2.7 V6 4x4 2.0 CRDi 2.0 CRDi 4x4, 83 kW	08.01 - 02.01 - 02.01 - 02.01 - 08.01 - 04.01 -			









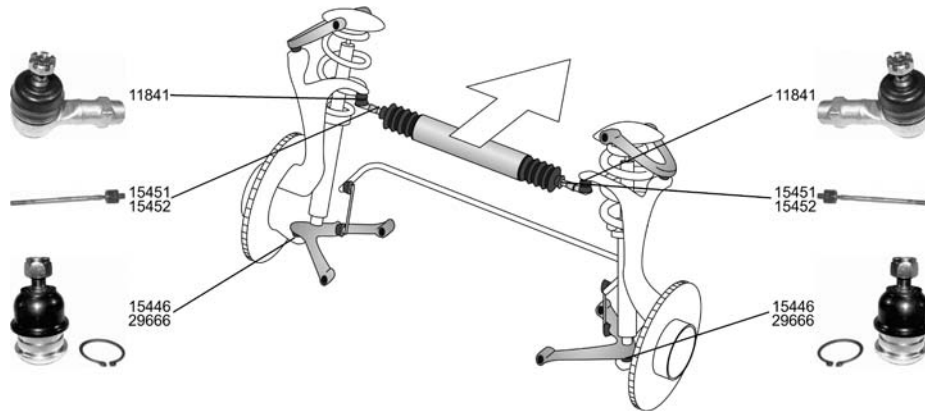





# HYUNDAI

SONATA I (Y-2)

09.88 - 10.93



<p><b>Spurstangenkopf / Tie-rod End</b>                      Gewindeart: mit Rechtsgewinde / Thread Type: with right-hand thread                      Innengewinde [mm] / Inner Thread [mm]:M14x1,5</p> <p>2.0 i, 80 kW 01.91 - 10.93                      2.0 i 16V 01.91 - 10.93                      3.0 i V6 01.91 - 10.93</p>		<p><b>11841</b> 56820-36000</p> 
<p><b>Axialgelenk, Spurstange / Axial Rod, tie rod</b></p> <p>1.8 i 09.88 - 10.93                      2.0 i 09.88 - 10.93                      2.4 i 09.88 - 08.91</p>		<p><b>15451</b> 57730-33100</p> 
<p><b>Axialgelenk, Spurstange / Axial Rod, tie rod</b>                      Gewindemaß / Thread Size:M14x1,5                      Gewindeart: mit Rechtsgewinde / Thread Type: with right-hand thread                      ALL TYPES</p>		<p><b>15452</b> 57730-33200</p> 
<p><b>Trag-/Führungsgelenk / Support-/ Steering Link</b>                      ALL TYPES</p>		<p><b>15446</b> 54503-25A00</p> 
<p><b>Trag-/Führungsgelenk / Support-/ Steering Link</b>                      ALL TYPES</p>		<p><b>29666</b> 54503-25A00</p>
<p> <b>Stange/Strebe, Stabilisator / Rod/Strut, stabiliser</b>                      Pendelstange / Suspension Rod</p> <p>2.0 i, 80 kW 01.91 - 10.93                      2.0 i 16V 01.91 - 10.93                      3.0 i V6 01.91 - 10.93</p>		<p><b>24694</b> 54830-36101</p> 













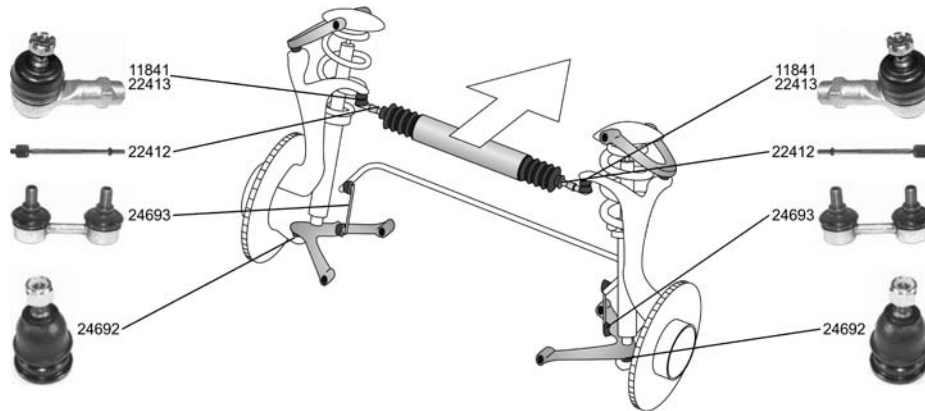







OE

# HYUNDAI

SONATA II (Y-3)

05.93 - 06.98



<p><b>Spurstangenkopf / Tie-rod End</b>                      Gewindeart: mit Rechtsgewinde / Thread Type: with right-hand thread                      Innengewinde [mm] / Inner Thread [mm]:M14x1,5                      ALL TYPES ausser/except for :                      1.8 i 05.93 - 06.98</p>		<p><b>11841</b> 56820-36000</p> 
<p><b>Spurstangenkopf / Tie-rod End</b>                      ALL TYPES ausser/except for :                      1.8 i 05.93 - 06.98</p>		<p><b>22413</b> 56820-37000</p> 
<p><b>Axialgelenk, Spurstange / Axial Rod, tie rod</b>                      ALL TYPES ausser/except for :                      1.8 i 05.93 - 06.98</p>		<p><b>22412</b> 57716-34000</p> 
<p><b>Lenker, Radaufhängung / Track Control Arm</b>                      2.0 i, 77 kW 06.94 - 08.96                      2.0 i 16V, 102 kW 05.93 - 06.98                      3.0 i V6 05.93 - 06.98</p>		<p><b>24695</b> 55250-34000</p> 
<p><b>Trag-/Führungsgelenk / Support-/ Steering Link</b>                      2.0 i 06.94 - 06.98                      2.0 i 16V, 92 kW 06.96 - 06.98                      2.0 i 16V, 102 kW 05.93 - 06.98                      3.0 i V6 05.93 - 06.98</p>		<p><b>24692</b> 54503-34A01</p> 
<p><b>Stange/Strebe, Stabilisator / Rod/Strut, stabiliser</b>                      Pendelstange / Suspension Rod                      ALL TYPES ausser/except for :                      1.8 i 05.93 - 06.98</p>		<p><b>24693</b> 54830-34000</p> 
<p> <b>Stange/Strebe, Stabilisator / Rod/Strut, stabiliser</b>                      Pendelstange / Suspension Rod                      ALL TYPES</p>		<p><b>24696</b> 55580-37020</p> 





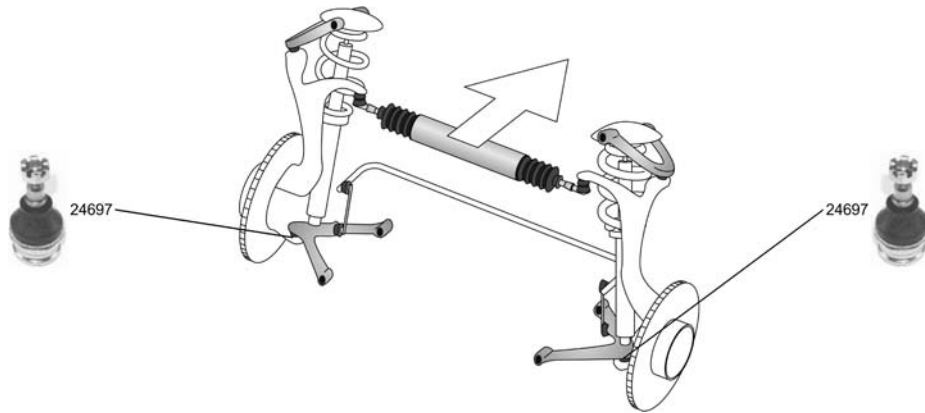

# HYUNDAI

SONATA III (EF)

03.98 - 10.01





<b>Trag-/Führungsgelenk / Support-/ Steering Link</b> ALL TYPES		<b>24697</b> 55730-37000 
<b>Faltenbalgsatz, Lenkung / Bellow Kit, steering system</b> ALL TYPES		<b>30195</b> 

# SONATA IV

10.01 -





<b>Faltenbalgsatz, Lenkung / Bellow Kit, steering system</b> 2.7 V6		<b>30195</b> 
--	---	---

# STELLAR

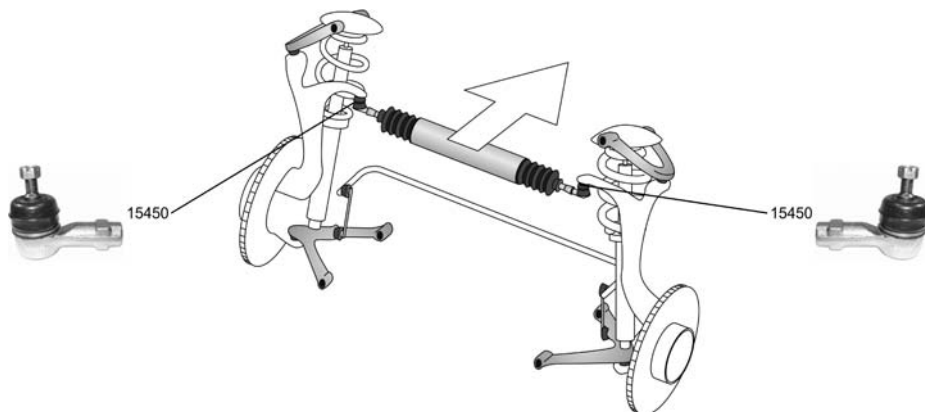
10.83 - 12.91



<b>Spurstangenkopf / Tie-rod End</b> Gewindeart: mit Rechtsgewinde / Thread Type: with right-hand thread 1.4      10.83 - 08.86 1.6      10.83 - 12.91		<b>15450</b> 56820-21100 
---	---	---





OE

# HYUNDAI

**TRAJET (FO) 03.00 -**

	<b>Spurstangenkopf / Tie-rod End</b>		<b>30357</b>	<b>56820-3B000</b>
	ALL TYPES			

**XG 12.98 -**

	<b>Faltenbalgsatz, Lenkung / Bellow Kit, steering system</b>		<b>30195</b>		
	25				12.98 -
	30/300				12.98 -

Arithmetische Liste / Part number list

Artikelnummer Article No.	Seite Page	Hersteller Manufacturer	Artikelnummer Article No.	Seite Page	Hersteller Manufacturer
11838	11 12	HYUNDAI	22412	17	HYUNDAI
Spurstangenkopf / Tie-rod End			Axialgelenk, Spurstange / Axial Rod, tie rod		
11841	9 10 16	HYUNDAI	22413	17	HYUNDAI
Spurstangenkopf / Tie-rod End	17		Spurstangenkopf / Tie-rod End		
11843	4 8	HYUNDAI	24685	4 9 10	HYUNDAI
Spurstangenkopf / Tie-rod End			Lenker, Radaufhängung / Track Control Arm		
11844	11 12	HYUNDAI	24686	4 9 10	HYUNDAI
Trag-/Führungsgelenk / Support-/ Steering Link			Lenker, Radaufhängung / Track Control Arm		
11845	11 12	HYUNDAI	24687	8	HYUNDAI
Trag-/Führungsgelenk / Support-/ Steering Link			Stange/Strebe, Stabilisator / Rod/Strut, stabiliser		
14950	1 2 13	HYUNDAI	24688	4 9 11	HYUNDAI
Axialgelenk, Spurstange / Axial Rod, tie rod	14		Stange/Strebe, Stabilisator / Rod/Strut, stabiliser		
14952	1 2 8	HYUNDAI	24689	10 11	HYUNDAI
Spurstangenkopf / Tie-rod End			Stange/Strebe, Stabilisator / Rod/Strut, stabiliser		
14954	8	HYUNDAI	24690	13 14	HYUNDAI
Axialgelenk, Spurstange / Axial Rod, tie rod			Lenker, Radaufhängung / Track Control Arm		
14955	8	HYUNDAI	24691	13 15	HYUNDAI
Axialgelenk, Spurstange / Axial Rod, tie rod			Lenker, Radaufhängung / Track Control Arm		
14956	12 13 14	HYUNDAI	24692	17	HYUNDAI
Axialgelenk, Spurstange / Axial Rod, tie rod			Trag-/Führungsgelenk / Support-/ Steering Link		
15445	12 14 15	HYUNDAI	24693	17	HYUNDAI
Trag-/Führungsgelenk / Support-/ Steering Link			Stange/Strebe, Stabilisator / Rod/Strut, stabiliser		
15446	1 2 3	HYUNDAI	24694	16	HYUNDAI
Trag-/Führungsgelenk / Support-/ Steering Link	5 6 9		Stange/Strebe, Stabilisator / Rod/Strut, stabiliser		
15450	12 13 14	HYUNDAI	24695	17	HYUNDAI
Spurstangenkopf / Tie-rod End	18		Lenker, Radaufhängung / Track Control Arm		
15451	8 9 16	HYUNDAI	24696	17	HYUNDAI
Axialgelenk, Spurstange / Axial Rod, tie rod			Stange/Strebe, Stabilisator / Rod/Strut, stabiliser		
15452	16	HYUNDAI	24697	18	HYUNDAI
Axialgelenk, Spurstange / Axial Rod, tie rod			Trag-/Führungsgelenk / Support-/ Steering Link		
15560	4 8	HYUNDAI	24698	1 2 7	HYUNDAI
Spurstangenkopf / Tie-rod End			Axialgelenk, Spurstange / Axial Rod, tie rod	13	
22408	6 7	HYUNDAI	29662	3	HYUNDAI
Spurstangenkopf / Tie-rod End			Spurstangenkopf / Tie-rod End		
22409	1 2 12	HYUNDAI			
Axialgelenk, Spurstange / Axial Rod, tie rod	13 14				
22410	4 9 10	HYUNDAI			
Axialgelenk, Spurstange / Axial Rod, tie rod					

Artikelnummer Article No.	Seite Page	Hersteller Manufacturer	Artikelnummer Article No.	Seite Page	Hersteller Manufacturer
29666 ▾⊕	1 2 3	HYUNDAI			
Trag-/Führungsgelenk / Support-/ Steering Link	5 6 9 11 16				
30138 ⊕	4 13 14	HYUNDAI			
Faltenbalgsatz, Lenkung / Bellow Kit, steering system	15				
30195 ⊕	18 19	HYUNDAI			
Faltenbalgsatz, Lenkung / Bellow Kit, steering system					
30228	8 10 11	HYUNDAI			
Faltenbalgsatz, Lenkung / Bellow Kit, steering system					
30354 ⊕	3 5	HYUNDAI			
Spurstangenkopf / Tie-rod End					
30357 ⊕	6 15 19	HYUNDAI			
Spurstangenkopf / Tie-rod End					
30358 ▾⊕	3 4	HYUNDAI			
Trag-/Führungsgelenk / Support-/ Steering Link					
30359 ⊕	15	HYUNDAI			
Trag-/Führungsgelenk / Support-/ Steering Link					
30361 ⊕	15	HYUNDAI			
Stange/Strebe, Stabilisator / Rod/Strut, stabiliser					

Vergleichsliste / Cross reference list

Vergleichs-Nr. Compare No.	Artikelnummer Article No.	Vergleichs-Nr. Compare No.	Artikelnummer Article No.	Vergleichs-Nr. Compare No.	Artikelnummer Article No.
<b>HYUNDAI</b>					
54500-24000	24690				
54500-29000	24685				
54501-24000	24691				
54501-29000	24686				
54503-25A00	15446				
54503-25A00	29666				
54503-34A01	24692				
54503-3BA00	30359				
54530-02050	30358				
54530-21A00	11844				
54530-24A00	15445				
54540-21A00	11845				
54830-29000	24688				
54830-34000	24693				
54830-36101	24694				
54830-37020	24687				
54840-26000	30361				
55250-34000	24695				
55530-29000	24689				
55580-37020	24696				
55730-37000	24697				
56528-24000	30228				
56540-24001	14950				
56820-02500	29662				
56820-21100	15450				
56820-25000	30354				
56820-28000	11843				
56820-28500	14952				
56820-36000	11841				
56820-37000	22413				
56820-3B000	30357				
56872-43000	22408				
57716-34000	22412				
57730-24000	14956				
57730-28000	14954				
57730-28500	14955				
57730-29000	22410				
57730-33100	15451				
57730-33200	15452				
57730-43010	22409				
57755-22000	24698				

Neuaufnahmen / New to range

Artikelnummer Article No.	Seite Page	Hersteller Manufacturer	Artikelnummer Article No.	Seite Page	Hersteller Manufacturer
24685 ▾⊕	4 9 10	HYUNDAI	30138 ⊕	4 13 14	HYUNDAI
24686 ▾⊕	4 9 10	HYUNDAI		15	
24687 ⊕	8	HYUNDAI	30195 ⊕	18 19	HYUNDAI
24688 ⊕	4 9 11	HYUNDAI	30228	8 10 11	HYUNDAI
24689 ⊕	10 11	HYUNDAI	30354 ⊕	3 5	HYUNDAI
24692 ▾⊕	17	HYUNDAI	30357 ⊕	6 15 19	HYUNDAI
24693 ⊕	17	HYUNDAI	30358 ▾⊕	3 4	HYUNDAI
24694 ⊕	16	HYUNDAI	30359 ⊕	15	HYUNDAI
24696 ⊕	17	HYUNDAI	30361 ⊕	15	HYUNDAI
24697 ▾⊕	18	HYUNDAI			
29662 ⊕	3	HYUNDAI			
29666 ▾⊕	1 2 3	HYUNDAI			
	5 6 9				
	11 16				

**Geänderte Bestellnummer / Amended part numbers**

Artikelnummer alt Article No. old	Artikelnummer neu Article No. new	Artikelnummer alt Article No. old	Artikelnummer neu Article No. new	Artikelnummer alt Article No. old	Artikelnummer neu Article No. new
11838	15450				
11843	15560				
14951	11843				
14957	22409				
15442	30138				
15446	29666				

**Geänderte Bestellnummer / Amended part numbers**

Artikelnummer neu Article No. new	Artikelnummer alt Article No. old	Artikelnummer neu Article No. new	Artikelnummer alt Article No. old	Artikelnummer neu Article No. new	Artikelnummer alt Article No. old
11843	14951				
15450	11838				
15560	11843				
22409	14957				
29666	15446				
30138	15442				

© ZF Trading GmbH - 14.10.06