











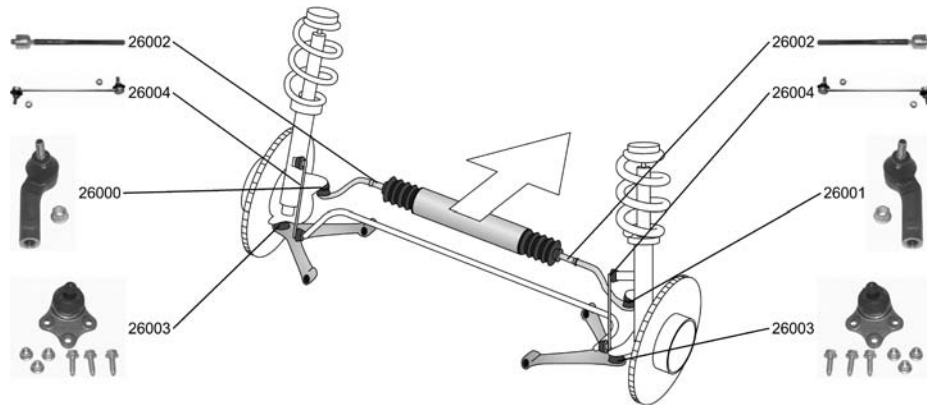

OE

MAZDA

2 (B2W)

04.03 -





<p>Spurstangenkopf / Tie-rod End mit Zubehör / With accessories Innengewinde [mm] / Inner Thread [mm]:M12x1,5 Aussengewinde [mm] / Outer Thread [mm]:M10x1,5 ALL TYPES</p>		<p>26000 DE90-32-290</p> 
<p>Spurstangenkopf / Tie-rod End mit Zubehör / With accessories Innengewinde [mm] / Inner Thread [mm]:M12x1,5 Aussengewinde [mm] / Outer Thread [mm]:M10x1,5 ALL TYPES</p>		<p>26001 DE90-32-280</p> 
<p>Axialgelenk, Spurstange / Axial Rod, tie rod ALL TYPES</p>		<p>26002 DE90-32-240</p> 
<p>Trag-/Führungsgelenk / Support-/ Steering Link ALL TYPES</p>		<p>26003</p> 
<p>Stange/Strebe, Stabilisator / Rod/Strut, stabiliser Pendelstange / Suspension Rod ALL TYPES</p>		<p>26004 DD32-34-170</p> 

3 (BK14)

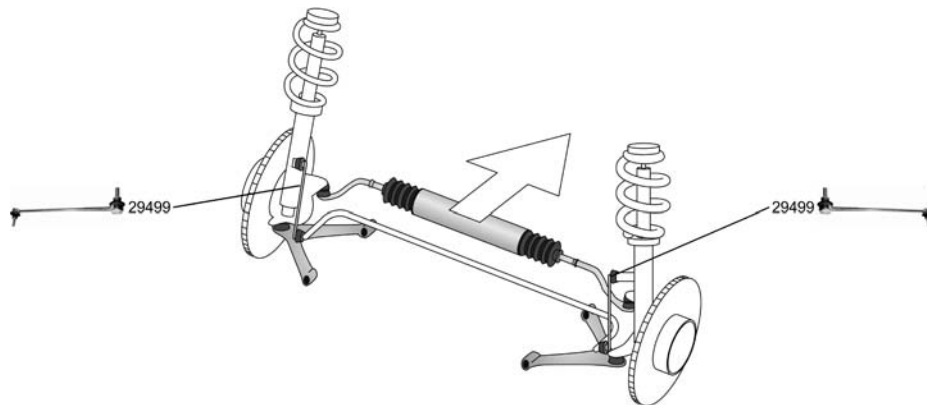
10.03 -



<p>Stange/Strebe, Stabilisator / Rod/Strut, stabiliser Pendelstange / Suspension Rod Länge innen [mm] / Inner Length [mm]:298,1 ALL TYPES</p>		<p>29499 BP4K-34-170C</p> 
--	---	--



MAZDA

3 Stufenheck (BK12)

02.04 -

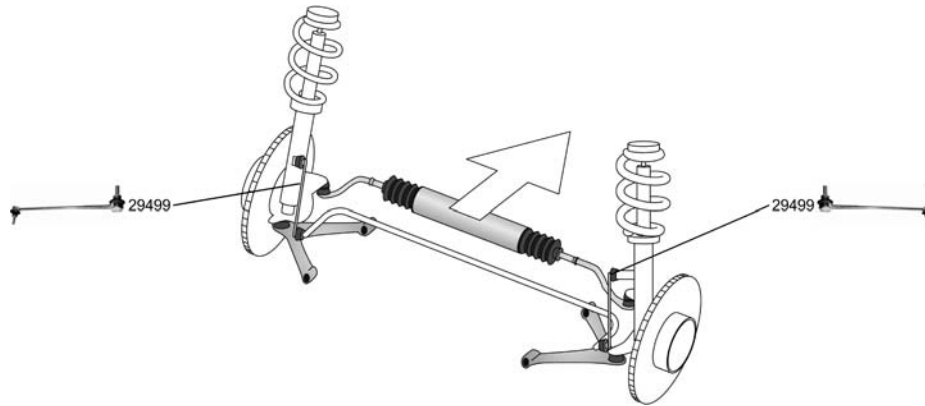

Stange/Strebe, Stabilisator / Rod/Strut, stabiliser Pendelstange / Suspension Rod Länge innen [mm] / Inner Length [mm]:298,1 ALL TYPES	↔	29499 BP4K-34-170C 
--	---	---

6 (GG)

06.02 -



Faltenbalsatz, Lenkung / Bellow Kit, steering system ALL TYPES ausser/except for : 2.0, 108 kW 03.05 - 2.3 MPS 12.05 - 2.0 DI, 105 kW 06.05 -	↔	30247 S47P32125
---	---	-------------------------------

6 Hatchback (GG)

08.02 -



Faltenbalsatz, Lenkung / Bellow Kit, steering system ALL TYPES ausser/except for : 2.0, 108 kW 03.05 - 2.0 DI, 105 kW 06.05 -	↔	30247 S47P32125
---	---	-------------------------------

6 Station Wagon (GY)

08.02 -



Faltenbalsatz, Lenkung / Bellow Kit, steering system ALL TYPES ausser/except for : 2.0, 108 kW 03.05 - 2.3 AWD 11.02 - 2.0 DI, 105 kW 06.05 -	↔	30247 S47P32125
---	---	-------------------------------







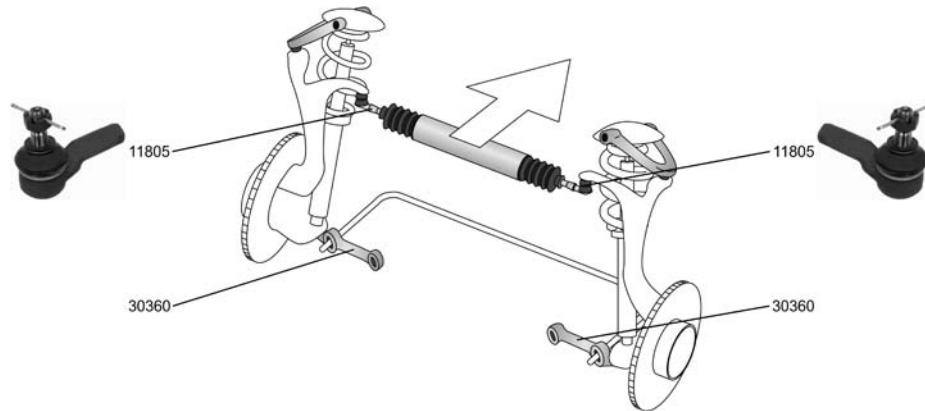

OE

MAZDA

121 I (DA)

10.87 - 10.90





<p>Spurstangenkopf / Tie-rod End Gewindeart: mit Rechtsgewinde / Thread Type: with right-hand thread Gewindemaß / Thread Size: M12x1,25 ALL TYPES</p>		<p>11805 8AB1-32-280</p> 
<p>Lenker, Radaufhängung / Track Control Arm ALL TYPES</p>		<p>30360</p>
<p>Faltenbalgsatz, Lenkung / Bellow Kit, steering system ALL TYPES</p>		<p>30193</p> 

121 II (DB)

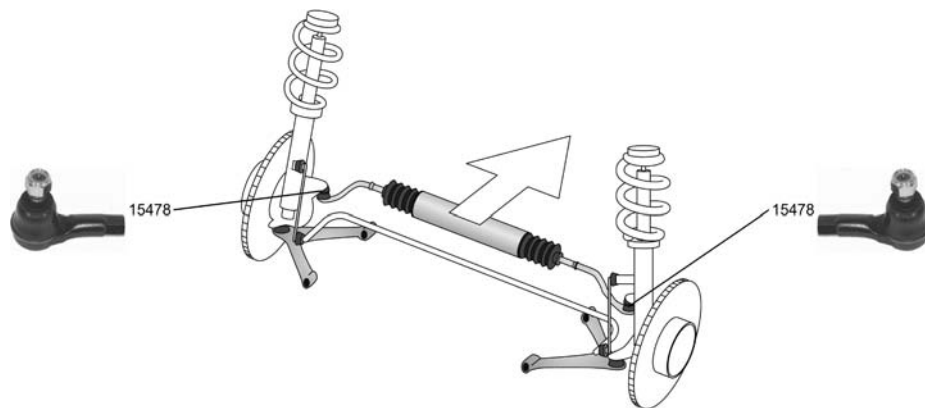
11.90 - 03.96



<p>Spurstangenkopf / Tie-rod End Gewindeart: mit Rechtsgewinde / Thread Type: with right-hand thread 1.3 16V 11.90 - 03.96</p>		<p>15478 8AB2-32-280</p> 
--	---	--



MAZDA

121 III (JASM, JBSM)

03.96 -

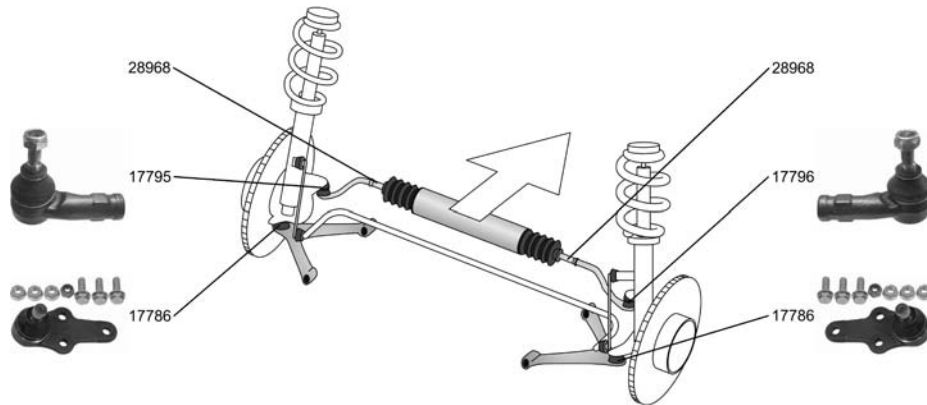

<p>Spurstangenkopf / Tie-rod End Gewindeart: mit Rechtsgewinde / Thread Type: with right-hand thread Gewindemaß / Thread Size:M10x1,5</p>		<p>17795 1E01-32-280 A</p>
<p>ALL TYPES</p>		
<p>Spurstangenkopf / Tie-rod End Gewindeart: mit Rechtsgewinde / Thread Type: with right-hand thread Gewindemaß / Thread Size:M10x1,5</p>		<p>17796 1E00-32-280 A</p>
<p>ALL TYPES</p>		
<p>Axialgelenk, Spurstange / Axial Rod, tie rod radseitig / Wheel Side Aussengewinde [mm] / Outer Thread [mm]:16 Gewindemaß / Thread Size:M16x1,5</p>		<p>28968 1E00 32 240</p>
<p>ALL TYPES</p>		
<p>Trag-/Führungsgelenk / Support-/ Steering Link mit Zubehör / With accessories</p>		<p>17786</p>
<p>ALL TYPES</p>		
<p>Lagerung, Lenker / Mounting, wishbone</p>		<p>27308 1E01-34-153A</p>
<p>ALL TYPES</p>		
<p>Lagerung, Lenker / Mounting, wishbone Länge [cm] / Length [cm]:62</p>		<p>112/A37 27408 1E00-34-153A</p>
<p>ALL TYPES</p>		

323 I Station Wagon/Estate/Break (FA)

05.78 - 05.86



Trag-/Führungsgelenk / Support-/ Steering Link
 ALL TYPES



11804 8531-99-356















OE

MAZDA

323 II (BD) 11.80 - 10.89





 Spurstangenkopf / Tie-rod End Gewindeart: mit Rechtsgewinde / Thread Type: with right-hand thread Gewindemaß / Thread Size:M12x1,25 ALL TYPES ausser/except for : 1.5, 59 kW 11.80 - 07.85		11808 B001-99-325 
Trag-/Führungsgelenk / Support-/ Steering Link ALL TYPES ausser/except for : 1.5, 59 kW 11.80 - 07.85		11807 B092-34-550 

323 II Hatchback/avec hayon (BD) 06.80 - 10.89

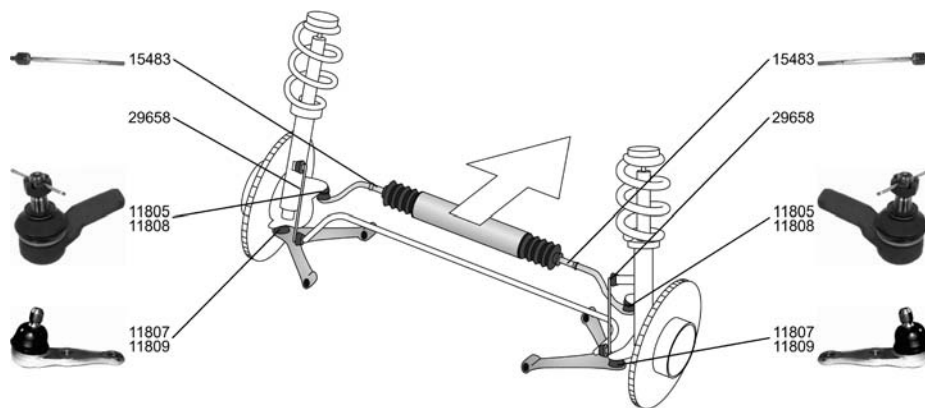
 Spurstangenkopf / Tie-rod End Gewindeart: mit Rechtsgewinde / Thread Type: with right-hand thread Gewindemaß / Thread Size:M12x1,25 ALL TYPES		11808 B001-99-325 
Trag-/Führungsgelenk / Support-/ Steering Link ALL TYPES		11807 B092-34-550 

323 III (BF) 08.85 - 04.90













Spurstangenkopf / Tie-rod End Gewindeart: mit Rechtsgewinde / Thread Type: with right-hand thread Gewindemaß / Thread Size:M12x1,25 ALL TYPES ausser/except for : 1.1 08.85 - 04.90 1.4 04.87 - 07.89 1.7 D, 42 kW 01.87 - 05.89		11805 8AB1-32-280 
Spurstangenkopf / Tie-rod End Gewindeart: mit Rechtsgewinde / Thread Type: with right-hand thread Gewindemaß / Thread Size:M12x1,25 ALL TYPES ausser/except for : 1.1 08.85 - 04.90 1.4 04.87 - 07.89 1.7 D, 42 kW 01.87 - 05.89		11808 B001-99-325 



MAZDA

323 III (BF)



08.85 - 04.90

<p> Axialgelenk, Spurstange / Axial Rod, tie rod Gewindemaß / Thread Size:M12x1,25 Gewindeart: mit Rechtsgewinde / Thread Type: with right-hand thread Achsausführung / Axle Version:C.R.G.</p>		<p>15483 B094-32-240</p> 										
<p>ALL TYPES ausser/except for :</p> <table border="1"> <tr><td>1.1</td><td>08.85 - 04.90</td></tr> <tr><td>1.4</td><td>04.87 - 07.89</td></tr> <tr><td>1.7 D, 42 kW</td><td>01.87 - 05.89</td></tr> </table>	1.1	08.85 - 04.90	1.4	04.87 - 07.89	1.7 D, 42 kW	01.87 - 05.89						
1.1	08.85 - 04.90											
1.4	04.87 - 07.89											
1.7 D, 42 kW	01.87 - 05.89											
<p>Trag-/Führungsgelenk / Support-/ Steering Link ALL TYPES ausser/except for :</p> <table border="1"> <tr><td>1.1</td><td>08.85 - 04.90</td></tr> <tr><td>1.4</td><td>04.87 - 07.89</td></tr> <tr><td>1.7 D, 42 kW</td><td>01.87 - 05.89</td></tr> </table>	1.1	08.85 - 04.90	1.4	04.87 - 07.89	1.7 D, 42 kW	01.87 - 05.89		<p>11807 B092-34-550</p> 				
1.1	08.85 - 04.90											
1.4	04.87 - 07.89											
1.7 D, 42 kW	01.87 - 05.89											
<p>Trag-/Führungsgelenk / Support-/ Steering Link ohne Zubehör / without accessories</p> <table border="1"> <tr><td>1.7 D, 42 kW</td><td>01.87 - 05.89</td></tr> </table>	1.7 D, 42 kW	01.87 - 05.89	 <p>Chass. 630912-></p>	<p>11809 B01A-34-550 A</p> 								
1.7 D, 42 kW	01.87 - 05.89											
<p>Stange/Strebe, Stabilisator / Rod/Strut, stabiliser Pendelstange / Suspension Rod</p> <table border="1"> <tr><td>1.7 D, 42 kW</td><td>01.87 - 05.89</td></tr> </table>	1.7 D, 42 kW	01.87 - 05.89		<p>29658 B26R-34-170</p>								
1.7 D, 42 kW	01.87 - 05.89											
<p>Faltenbaldsatz, Lenkung / Bellow Kit, steering system</p> <table border="1"> <tr><td>1.3</td><td>08.85 - 05.89</td></tr> <tr><td>1.5</td><td>08.85 - 10.89</td></tr> <tr><td>1.6 GT</td><td>01.86 - 10.89</td></tr> <tr><td>1.6 GT Turbo</td><td>10.85 - 11.91</td></tr> <tr><td>1.7 D, 40 kW</td><td>09.86 - 05.89</td></tr> </table>	1.3	08.85 - 05.89	1.5	08.85 - 10.89	1.6 GT	01.86 - 10.89	1.6 GT Turbo	10.85 - 11.91	1.7 D, 40 kW	09.86 - 05.89		<p>30141 H002-32-125</p> 
1.3	08.85 - 05.89											
1.5	08.85 - 10.89											
1.6 GT	01.86 - 10.89											
1.6 GT Turbo	10.85 - 11.91											
1.7 D, 40 kW	09.86 - 05.89											

323 III Hatchback/avec hayon (BF)

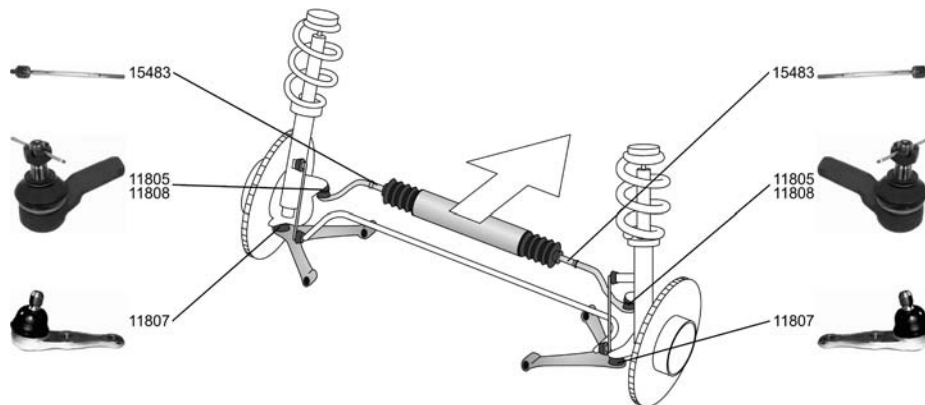
08.85 - 11.91



<p>Spurstangenkopf / Tie-rod End Gewindeart: mit Rechtsgewinde / Thread Type: with right-hand thread Gewindemaß / Thread Size:M12x1,25</p>		<p>11805 8AB1-32-280</p> 																								
<table border="1"> <tr><td>1.1</td><td>09.85 - 10.89</td></tr> <tr><td>1.3</td><td>09.85 - 12.87</td></tr> <tr><td>1.4</td><td>09.87 - 10.89</td></tr> <tr><td>1.5</td><td>08.85 - 10.89</td></tr> <tr><td>1.5 i</td><td>08.85 - 05.89</td></tr> <tr><td>1.5 i Turbo</td><td>08.85 - 05.89</td></tr> <tr><td>1.6</td><td>09.87 - 10.89</td></tr> <tr><td>1.6 GT</td><td>08.85 - 10.89</td></tr> <tr><td>1.6 GT Turbo 4WD (BF2)</td><td>08.87 - 10.89</td></tr> <tr><td>1.6 GT Turbo (BF1)</td><td>10.85 - 11.91</td></tr> <tr><td>1.6 GT Turbo 4WD (BF2)</td><td>10.87 - 11.91</td></tr> <tr><td>1.7 D</td><td>04.86 - 05.89</td></tr> </table>	1.1	09.85 - 10.89	1.3	09.85 - 12.87	1.4	09.87 - 10.89	1.5	08.85 - 10.89	1.5 i	08.85 - 05.89	1.5 i Turbo	08.85 - 05.89	1.6	09.87 - 10.89	1.6 GT	08.85 - 10.89	1.6 GT Turbo 4WD (BF2)	08.87 - 10.89	1.6 GT Turbo (BF1)	10.85 - 11.91	1.6 GT Turbo 4WD (BF2)	10.87 - 11.91	1.7 D	04.86 - 05.89		
1.1	09.85 - 10.89																									
1.3	09.85 - 12.87																									
1.4	09.87 - 10.89																									
1.5	08.85 - 10.89																									
1.5 i	08.85 - 05.89																									
1.5 i Turbo	08.85 - 05.89																									
1.6	09.87 - 10.89																									
1.6 GT	08.85 - 10.89																									
1.6 GT Turbo 4WD (BF2)	08.87 - 10.89																									
1.6 GT Turbo (BF1)	10.85 - 11.91																									
1.6 GT Turbo 4WD (BF2)	10.87 - 11.91																									
1.7 D	04.86 - 05.89																									













OE

MAZDA

323 III Hatchback/avec hayon (BF)

08.85 - 11.91

<p> Spurstangenkopf / Tie-rod End Gewindeart: mit Rechtsgewinde / Thread Type: with right-hand thread Gewindemaß / Thread Size:M12x1,25</p>		<p>11808 B001-99-325</p> 																								
<table border="0"> <tr><td>1.1</td><td>09.85 - 10.89</td></tr> <tr><td>1.3</td><td>09.85 - 12.87</td></tr> <tr><td>1.4</td><td>09.87 - 10.89</td></tr> <tr><td>1.5</td><td>08.85 - 10.89</td></tr> <tr><td>1.5 i</td><td>08.85 - 05.89</td></tr> <tr><td>1.5 i Turbo</td><td>08.85 - 05.89</td></tr> <tr><td>1.6</td><td>09.87 - 10.89</td></tr> <tr><td>1.6 GT</td><td>08.85 - 10.89</td></tr> <tr><td>1.6 GT Turbo 4WD (BF2)</td><td>08.87 - 10.89</td></tr> <tr><td>1.6 GT Turbo (BF1)</td><td>10.85 - 11.91</td></tr> <tr><td>1.6 GT Turbo 4WD (BF2)</td><td>10.87 - 11.91</td></tr> <tr><td>1.7 D</td><td>04.86 - 05.89</td></tr> </table>	1.1	09.85 - 10.89	1.3	09.85 - 12.87	1.4	09.87 - 10.89	1.5	08.85 - 10.89	1.5 i	08.85 - 05.89	1.5 i Turbo	08.85 - 05.89	1.6	09.87 - 10.89	1.6 GT	08.85 - 10.89	1.6 GT Turbo 4WD (BF2)	08.87 - 10.89	1.6 GT Turbo (BF1)	10.85 - 11.91	1.6 GT Turbo 4WD (BF2)	10.87 - 11.91	1.7 D	04.86 - 05.89		
1.1	09.85 - 10.89																									
1.3	09.85 - 12.87																									
1.4	09.87 - 10.89																									
1.5	08.85 - 10.89																									
1.5 i	08.85 - 05.89																									
1.5 i Turbo	08.85 - 05.89																									
1.6	09.87 - 10.89																									
1.6 GT	08.85 - 10.89																									
1.6 GT Turbo 4WD (BF2)	08.87 - 10.89																									
1.6 GT Turbo (BF1)	10.85 - 11.91																									
1.6 GT Turbo 4WD (BF2)	10.87 - 11.91																									
1.7 D	04.86 - 05.89																									
<p>Axialgelenk, Spurstange / Axial Rod, tie rod Gewindemaß / Thread Size:M12x1,25 Gewindeart: mit Rechtsgewinde / Thread Type: with right-hand thread Achsausführung / Axle Version:C.R.G.</p>		<p>15483 B094-32-240</p> 																								
<table border="0"> <tr><td>1.1</td><td>09.85 - 10.89</td></tr> <tr><td>1.3</td><td>09.85 - 12.87</td></tr> <tr><td>1.4</td><td>09.87 - 10.89</td></tr> <tr><td>1.5</td><td>08.85 - 10.89</td></tr> <tr><td>1.5 i</td><td>08.85 - 05.89</td></tr> <tr><td>1.5 i Turbo</td><td>08.85 - 05.89</td></tr> <tr><td>1.6</td><td>09.87 - 10.89</td></tr> <tr><td>1.6 GT</td><td>08.85 - 10.89</td></tr> <tr><td>1.6 GT Turbo 4WD (BF2)</td><td>08.87 - 10.89</td></tr> <tr><td>1.6 GT Turbo (BF1)</td><td>10.85 - 11.91</td></tr> <tr><td>1.6 GT Turbo 4WD (BF2)</td><td>10.87 - 11.91</td></tr> <tr><td>1.7 D</td><td>04.86 - 05.89</td></tr> </table>	1.1	09.85 - 10.89	1.3	09.85 - 12.87	1.4	09.87 - 10.89	1.5	08.85 - 10.89	1.5 i	08.85 - 05.89	1.5 i Turbo	08.85 - 05.89	1.6	09.87 - 10.89	1.6 GT	08.85 - 10.89	1.6 GT Turbo 4WD (BF2)	08.87 - 10.89	1.6 GT Turbo (BF1)	10.85 - 11.91	1.6 GT Turbo 4WD (BF2)	10.87 - 11.91	1.7 D	04.86 - 05.89		
1.1	09.85 - 10.89																									
1.3	09.85 - 12.87																									
1.4	09.87 - 10.89																									
1.5	08.85 - 10.89																									
1.5 i	08.85 - 05.89																									
1.5 i Turbo	08.85 - 05.89																									
1.6	09.87 - 10.89																									
1.6 GT	08.85 - 10.89																									
1.6 GT Turbo 4WD (BF2)	08.87 - 10.89																									
1.6 GT Turbo (BF1)	10.85 - 11.91																									
1.6 GT Turbo 4WD (BF2)	10.87 - 11.91																									
1.7 D	04.86 - 05.89																									
<p>Trag-/Führungsgelenk / Support-/ Steering Link</p> <table border="0"> <tr><td>1.1</td><td>09.85 - 10.89</td></tr> <tr><td>1.3</td><td>09.85 - 12.87</td></tr> <tr><td>1.4</td><td>09.87 - 10.89</td></tr> <tr><td>1.5</td><td>08.85 - 10.89</td></tr> <tr><td>1.5 i</td><td>08.85 - 05.89</td></tr> <tr><td>1.5 i Turbo</td><td>08.85 - 05.89</td></tr> <tr><td>1.6</td><td>09.87 - 10.89</td></tr> <tr><td>1.6 GT</td><td>08.85 - 10.89</td></tr> <tr><td>1.6 GT Turbo 4WD (BF2)</td><td>08.87 - 10.89</td></tr> <tr><td>1.6 GT Turbo (BF1)</td><td>10.85 - 11.91</td></tr> <tr><td>1.6 GT Turbo 4WD (BF2)</td><td>10.87 - 11.91</td></tr> <tr><td>1.7 D</td><td>04.86 - 05.89</td></tr> </table>	1.1	09.85 - 10.89	1.3	09.85 - 12.87	1.4	09.87 - 10.89	1.5	08.85 - 10.89	1.5 i	08.85 - 05.89	1.5 i Turbo	08.85 - 05.89	1.6	09.87 - 10.89	1.6 GT	08.85 - 10.89	1.6 GT Turbo 4WD (BF2)	08.87 - 10.89	1.6 GT Turbo (BF1)	10.85 - 11.91	1.6 GT Turbo 4WD (BF2)	10.87 - 11.91	1.7 D	04.86 - 05.89		<p>11807 B092-34-550</p> 
1.1	09.85 - 10.89																									
1.3	09.85 - 12.87																									
1.4	09.87 - 10.89																									
1.5	08.85 - 10.89																									
1.5 i	08.85 - 05.89																									
1.5 i Turbo	08.85 - 05.89																									
1.6	09.87 - 10.89																									
1.6 GT	08.85 - 10.89																									
1.6 GT Turbo 4WD (BF2)	08.87 - 10.89																									
1.6 GT Turbo (BF1)	10.85 - 11.91																									
1.6 GT Turbo 4WD (BF2)	10.87 - 11.91																									
1.7 D	04.86 - 05.89																									
<p>Faltenbalgsatz, Lenkung / Bellow Kit, steering system</p> <table border="0"> <tr><td>1.1</td><td>09.85 - 10.89</td></tr> <tr><td>1.3</td><td>09.85 - 12.87</td></tr> <tr><td>1.4</td><td>09.87 - 10.89</td></tr> <tr><td>1.5</td><td>08.85 - 10.89</td></tr> <tr><td>1.6</td><td>09.87 - 10.89</td></tr> <tr><td>1.6 GT</td><td>08.85 - 10.89</td></tr> <tr><td>1.6 GT Turbo (BF1)</td><td>10.85 - 11.91</td></tr> <tr><td>1.7 D</td><td>04.86 - 05.89</td></tr> </table>	1.1	09.85 - 10.89	1.3	09.85 - 12.87	1.4	09.87 - 10.89	1.5	08.85 - 10.89	1.6	09.87 - 10.89	1.6 GT	08.85 - 10.89	1.6 GT Turbo (BF1)	10.85 - 11.91	1.7 D	04.86 - 05.89		<p>30141 H002-32-125</p> 								
1.1	09.85 - 10.89																									
1.3	09.85 - 12.87																									
1.4	09.87 - 10.89																									
1.5	08.85 - 10.89																									
1.6	09.87 - 10.89																									
1.6 GT	08.85 - 10.89																									
1.6 GT Turbo (BF1)	10.85 - 11.91																									
1.7 D	04.86 - 05.89																									









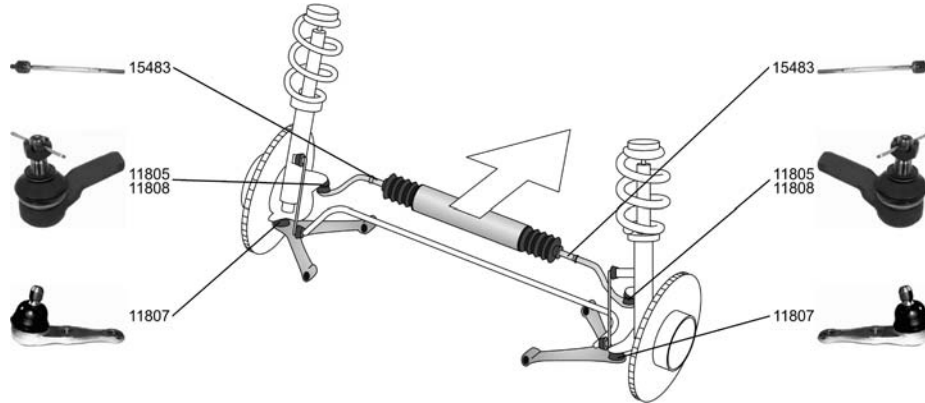



MAZDA

323 III Station Wagon/Estate/Break
(BW)

05.86 - 03.93



<p>Spurstangenkopf / Tie-rod End Gewindeart: mit Rechtsgewinde / Thread Type: with right-hand thread Gewindemaß / Thread Size:M12x1,25</p> <p>ALL TYPES ausser/except for : 1.3 01.86 - 04.90</p>		<p>11805 8AB1-32-280</p> 
<p>Spurstangenkopf / Tie-rod End Gewindeart: mit Rechtsgewinde / Thread Type: with right-hand thread Gewindemaß / Thread Size:M12x1,25</p> <p>ALL TYPES ausser/except for : 1.3 01.86 - 04.90</p>		<p>11808 B001-99-325</p> 
<p>Axialgelenk, Spurstange / Axial Rod, tie rod Gewindemaß / Thread Size:M12x1,25 Gewindeart: mit Rechtsgewinde / Thread Type: with right-hand thread Achsausführung / Axle Version:C.R.G.</p> <p>ALL TYPES ausser/except for : 1.3 01.86 - 04.90 1.6 4x4 05.90 - 03.93</p>	 	<p>15483 B094-32-240</p> 
<p>Trag-/Führungsgelenk / Support-/ Steering Link</p> <p>ALL TYPES ausser/except for : 1.3 01.86 - 04.90</p>		<p>11807 B092-34-550</p> 
<p>Faltenbalgsatz, Lenkung / Bellow Kit, steering system</p> <p>ALL TYPES ausser/except for : 1.3 01.86 - 04.90 1.6 4x4 05.90 - 03.93</p>		<p>30141 H002-32-125</p> 











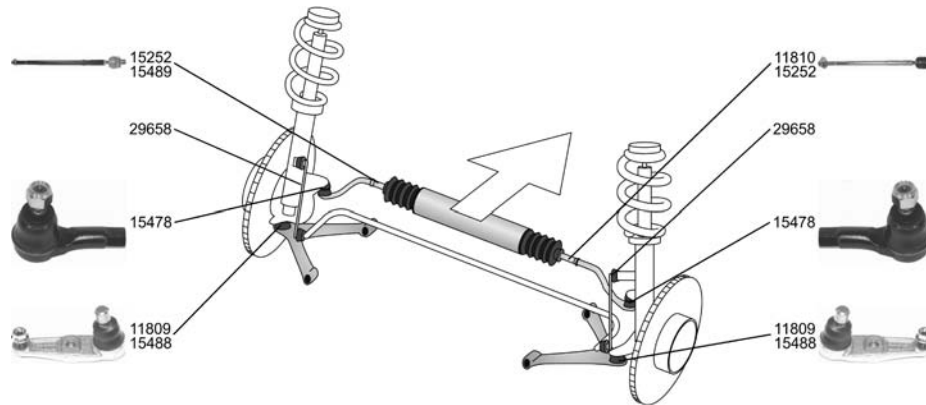







OE

MAZDA

323 C IV (BG)

06.89 - 10.94







<p>Spurstangenkopf / Tie-rod End Gewindeart: mit Rechtsgewinde / Thread Type: with right-hand thread</p> <p>ALL TYPES ausser/except for : 1.8 16V 09.89 - 03.93</p>		<p>15478 8AB2-32-280</p> 
<p>Axialgelenk, Spurstange / Axial Rod, tie rod Gewindemaß / Thread Size:M12x1,25 Gewindeart: mit Rechtsgewinde / Thread Type: with right-hand thread</p> <p>1.3 09.89 - 07.94 1.3 16V 09.89 - 07.94 1.6 09.89 - 06.91 1.8 16V GT 09.89 - 03.93 1.7 D 08.89 - 07.94</p>		<p>11810 B456-32-24X</p> 
<p>Axialgelenk, Spurstange / Axial Rod, tie rod</p> <p>ALL TYPES ausser/except for : 1.8 16V 09.89 - 03.93</p>	  für Lenkgetriebe-ID / For steering rack ID: NSK	<p>15252 B455-32-24X</p> 
<p>Axialgelenk, Spurstange / Axial Rod, tie rod Gewindemaß / Thread Size:M12x1,25 Gewindeart: mit Rechtsgewinde / Thread Type: with right-hand thread</p> <p>ALL TYPES ausser/except for : 1.8 16V 09.89 - 03.93</p>		<p>15489 B456-32-25X</p> 
<p>Trag-/Führungsgelenk / Support-/ Steering Link ohne Zubehör / without accessories</p> <p>1.6 09.89 - 06.91 1.8 16V 4WD 11.91 - 12.93 1.8 16V GT 09.89 - 03.93</p>	 Chass. 630912-> Mot. B5 Chass. 630912->	<p>11809 B01A-34-550 A</p> 
<p>Trag-/Führungsgelenk / Support-/ Steering Link</p> <p>1.3 09.89 - 07.94 1.3 16V 09.89 - 07.94 1.6 09.89 - 06.91 1.6 16V 03.91 - 10.94 1.8 16V 4WD 11.91 - 12.93 1.8 16V GT 09.89 - 03.93 1.8 16V Turbo 4WD, 120 kW 09.90 - 12.92 1.7 D 08.89 - 07.94 1.8 16V Turbo 4WD, 136 kW 01.93 - 07.94</p>	 ->Chass. 630911	<p>15488 B455-34-550</p> 
<p>Stange/Strebe, Stabilisator / Rod/Strut, stabiliser Pendelstange / Suspension Rod</p> <p>1.3 16V 09.89 - 07.94</p>		<p>23039 GA2A-34-170 A</p> 



MAZDA

323 C IV (BG)



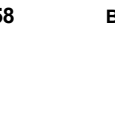





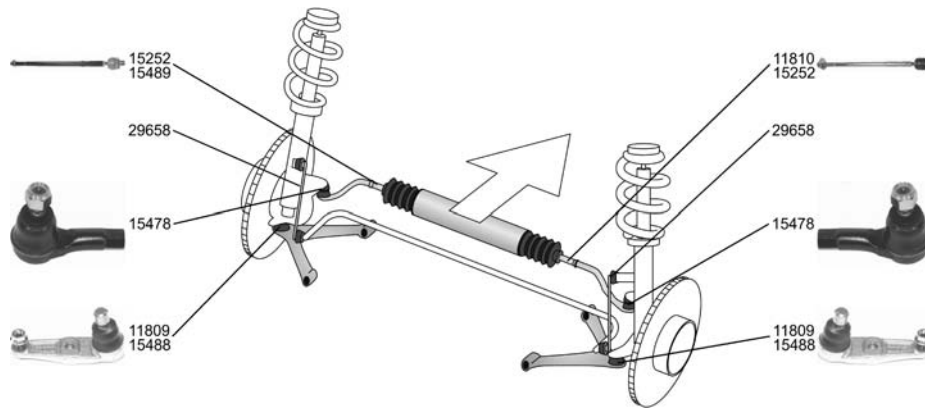

06.89 - 10.94

 Stange/Strebe, Stabilisator / Rod/Strut, stabiliser Pendelstange / Suspension Rod 1.3 16V	09.89 - 07.94		24938 GA2A-34-150 A 
	09.89 - 07.94		
Stange/Strebe, Stabilisator / Rod/Strut, stabiliser Pendelstange / Suspension Rod 1.3 1.6 1.6 16V 1.8 16V 4WD 1.8 16V GT	09.89 - 07.94		29658 B26R-34-170 
	09.89 - 06.91		
	03.91 - 10.94		
	11.91 - 12.93		
	09.89 - 03.93		

323 F IV (BG)

06.89 - 10.94







Spurstangenkopf / Tie-rod End Gewindart: mit Rechtsgewinde / Thread Type: with right-hand thread ALL TYPES ausser/except for : 1.8 16V, 103 kW	09.89 - 03.93		15478 8AB2-32-280 
	09.89 - 03.93		
Axialgelenk, Spurstange / Axial Rod, tie rod Gewindemaß / Thread Size: M12x1,25 Gewindart: mit Rechtsgewinde / Thread Type: with right-hand thread 1.6 1.6 16V 1.8 16V, 76 kW 1.8 16V GT	09.89 - 06.91		11810 B456-32-24X 
	03.91 - 10.94		
	08.89 - 07.94		
	08.89 - 07.94		
Axialgelenk, Spurstange / Axial Rod, tie rod 1.6 1.6 16V 1.8 16V, 76 kW 1.8 16V GT	09.89 - 06.91	 für Lenkgetriebe-ID / For steering rack ID: NSK	15252 B455-32-24X 
	03.91 - 10.94		
	08.89 - 07.94		
	08.89 - 07.94		
Axialgelenk, Spurstange / Axial Rod, tie rod Gewindemaß / Thread Size: M12x1,25 Gewindart: mit Rechtsgewinde / Thread Type: with right-hand thread 1.6 1.6 16V 1.8 16V, 76 kW 1.8 16V GT	09.89 - 06.91		15489 B456-32-25X 
	03.91 - 10.94		
	08.89 - 07.94		
	08.89 - 07.94		
Trag-/Führungsgelenk / Support-/ Steering Link ohne Zubehör / without accessories 1.6 16V	03.91 - 10.94	 Mot. B67L Chass. 630912->	11809 B01A-34-550 A 
	03.91 - 10.94		



OE









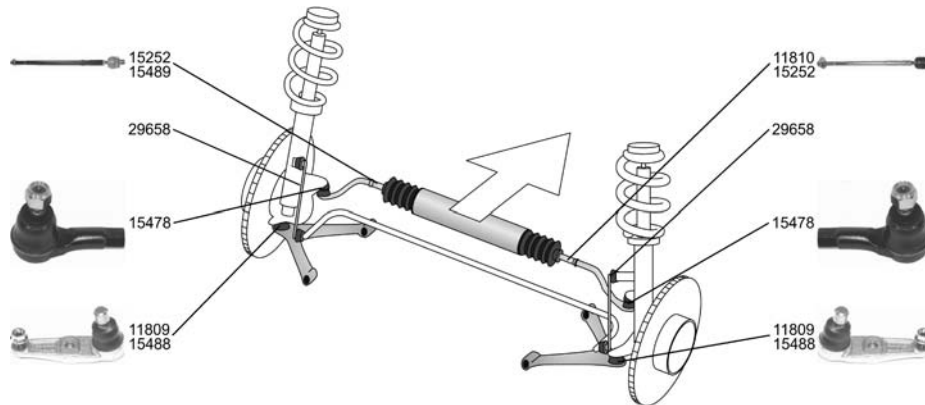



MAZDA

323 F IV (BG) 06.89 - 10.94

 Trag-/Führungsgelenk / Support-/ Steering Link ALL TYPES ausser/except for : 1.8 16V, 103 kW 09.89 - 03.93		15488 B455-34-550 
	Stange/Strebe, Stabilisator / Rod/Strut, stabiliser Pendelstange / Suspension Rod 1.6 16V 03.91 - 10.94	

323 S IV (BG) 06.89 - 10.94







Spurstangenkopf / Tie-rod End Gewindeart: mit Rechtsgewinde / Thread Type: with right-hand thread 1.3 09.89 - 06.91		15478 8AB2-32-280 	
	1.3 16V 04.91 - 07.94 1.6 09.89 - 06.91 1.6 16V 08.89 - 10.94 1.8 16V 08.89 - 07.94 1.8 16V 4WD 09.91 - 07.94 1.8 16V GT 06.89 - 07.94 1.8 16V Turbo 4WD 01.91 - 07.94 1.7 D 08.89 - 07.94		
Axialgelenk, Spurstange / Axial Rod, tie rod Gewindemaß / Thread Size: M12x1,25 Gewindeart: mit Rechtsgewinde / Thread Type: with right-hand thread ALL TYPES ausser/except for : 1.8 16V 4WD 09.91 - 07.94 1.8 16V Turbo 4WD 01.91 - 07.94		11810 B456-32-24X 	
Axialgelenk, Spurstange / Axial Rod, tie rod ALL TYPES ausser/except for : 1.8 16V 4WD 09.91 - 07.94		15252 B455-32-24X 	
für Lenkgetriebe-ID / For steering rack ID: NSK			
Axialgelenk, Spurstange / Axial Rod, tie rod Gewindemaß / Thread Size: M12x1,25 Gewindeart: mit Rechtsgewinde / Thread Type: with right-hand thread ALL TYPES ausser/except for : 1.8 16V 4WD 09.91 - 07.94		15489 B456-32-25X 	
Trag-/Führungsgelenk / Support-/ Steering Link ohne Zubehör / without accessories		11809 B01A-34-550 A 	
	1.3 09.89 - 06.91 1.6 09.89 - 06.91 1.8 16V 08.89 - 07.94 1.7 D 08.89 - 07.94 1.6 16V 08.89 - 10.94		Chass. 630912->
	1.8 16V Turbo 4WD 01.91 - 07.94		Mot. B61S, B67L Chass. 630912->
			Mot. BP Chass. 630912->



MAZDA

323 S IV (BG)









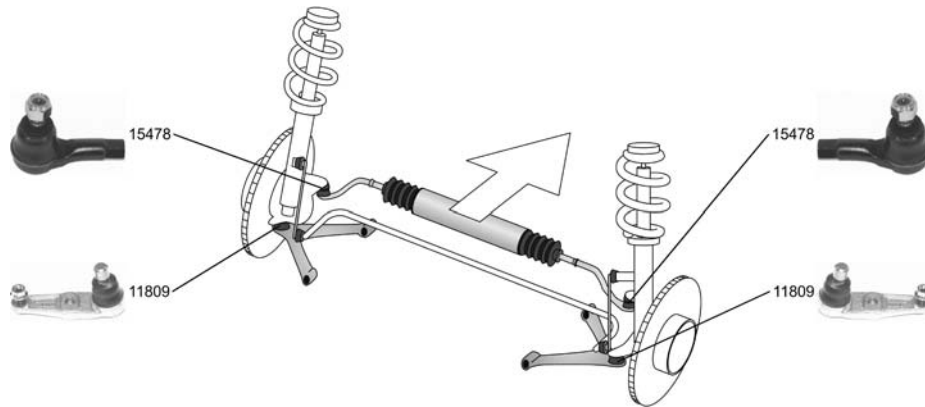

06.89 - 10.94

	Trag-/Führungsgelenk / Support-/ Steering Link ALL TYPES	 ->Chass. 630911	15488	B455-34-550
				
	Stange/Strebe, Stabilisator / Rod/Strut, stabiliser Pendelstange / Suspension Rod		29658	B26R-34-170
	1.3	09.89 - 06.91		
	1.6	09.89 - 06.91		
	1.8 16V	08.89 - 07.94		
	1.6 16V	08.89 - 10.94	Mot. B61S,B67L	
	1.7 D	08.89 - 07.94	Mot. PN62	
	1.8 16V Turbo 4WD	01.91 - 07.94	Mot. BP	

323 C V (BA)

08.94 - 09.98



	Spurstangenkopf / Tie-rod End Gewindeart: mit Rechtsgewinde / Thread Type: with right-hand thread		15478	8AB2-32-280
	1.3 16V	08.94 - 09.98		
	1.5 16V	08.94 - 09.98		
	1.8 16V	08.94 - 09.98		
	Trag-/Führungsgelenk / Support-/ Steering Link ohne Zubehör / without accessories		11809	B01A-34-550 A
	1.3 16V	08.94 - 09.98		
	1.5 16V	08.94 - 09.98		
	1.8 16V	08.94 - 09.98		
	Stange/Strebe, Stabilisator / Rod/Strut, stabiliser Pendelstange / Suspension Rod		23039	GA2A-34-170 A
	1.3 16V	08.94 - 09.98		
	1.5 16V	08.94 - 09.98		
	1.8 16V	08.94 - 09.98		
	Stange/Strebe, Stabilisator / Rod/Strut, stabiliser Pendelstange / Suspension Rod		24938	GA2A-34-150 A
	1.3 16V	08.94 - 09.98		
	1.5 16V	08.94 - 09.98		
	1.8 16V	08.94 - 09.98		
	Faltenbalgsatz, Lenkung / Bellow Kit, steering system		30239	BJ25-32-125
	1.3 16V	08.94 - 09.98		
	1.5 16V	08.94 - 09.98		
	1.8 16V	08.94 - 09.98		











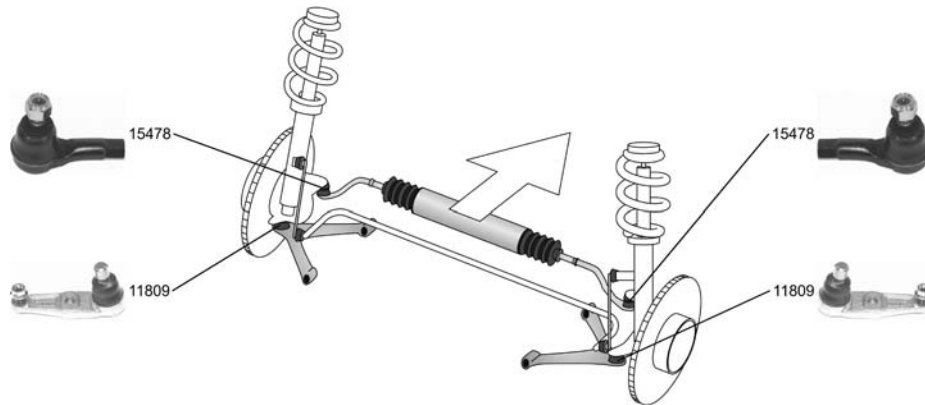

OE

MAZDA

323 F V (BA)

07.94 - 09.98



<p>Spurstangenkopf / Tie-rod End Gewindeart: mit Rechtsgewinde / Thread Type: with right-hand thread ALL TYPES ausser/except for : 1.3 16V 10.96 - 09.98</p>		<p>15478 8AB2-32-280</p> 
<p>Trag-/Führungsgelenk / Support-/ Steering Link ohne Zubehör / without accessories ALL TYPES ausser/except for : 1.3 16V 10.96 - 09.98</p>		<p>11809 B01A-34-550 A</p> 
<p>Stange/Strebe, Stabilisator / Rod/Strut, stabiliser Pendelstange / Suspension Rod 1.5 16V 07.94 - 09.98 1.8 16V 08.94 - 09.98 2.0 24V 08.94 - 09.98</p>		<p>23039 GA2A-34-170 A</p> 
<p>Stange/Strebe, Stabilisator / Rod/Strut, stabiliser Pendelstange / Suspension Rod 1.5 16V 07.94 - 09.98 1.8 16V 08.94 - 09.98 2.0 24V 08.94 - 09.98</p>		<p>24938 GA2A-34-150 A</p> 
<p>Faltenbalgsatz, Lenkung / Bellow Kit, steering system 1.5 16V 07.94 - 09.98 2.0 24V 08.94 - 09.98</p>		<p>30231 NC10-32-125</p>
<p>Faltenbalgsatz, Lenkung / Bellow Kit, steering system 1.8 16V 08.94 - 09.98</p>		<p>30239 BJ25-32-125</p>









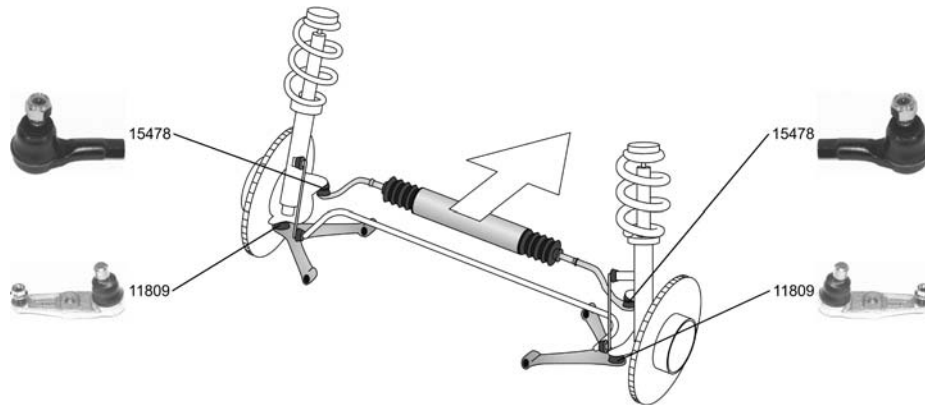



MAZDA

323 P V (BA)

10.96 - 09.98



<p>Spurstangenkopf / Tie-rod End Gewindeart: mit Rechtsgewinde / Thread Type: with right-hand thread ALL TYPES</p>		<p>15478 8AB2-32-280</p> 
<p>Trag-/Führungsgelenk / Support-/ Steering Link ohne Zubehör / without accessories 2.0 D 10.96 -</p>	 <p>Mot. RF1G ->12.1998</p>	<p>11809 B01A-34-550 A</p> 
<p>Stange/Strebe, Stabilisator / Rod/Strut, stabiliser Pendelstange / Suspension Rod ALL TYPES</p>		<p>23039 GA2A-34-170 A</p> 
<p>Stange/Strebe, Stabilisator / Rod/Strut, stabiliser Pendelstange / Suspension Rod ALL TYPES</p>		<p>24938 GA2A-34-150 A</p> 
<p>Faltenbalgsatz, Lenkung / Bellow Kit, steering system 1.5 16V 10.96 -</p>		<p>30231 NC10-32-125</p>
<p>Faltenbalgsatz, Lenkung / Bellow Kit, steering system 1.3 16V 10.96 -</p>		<p>30239 BJ25-32-125</p>











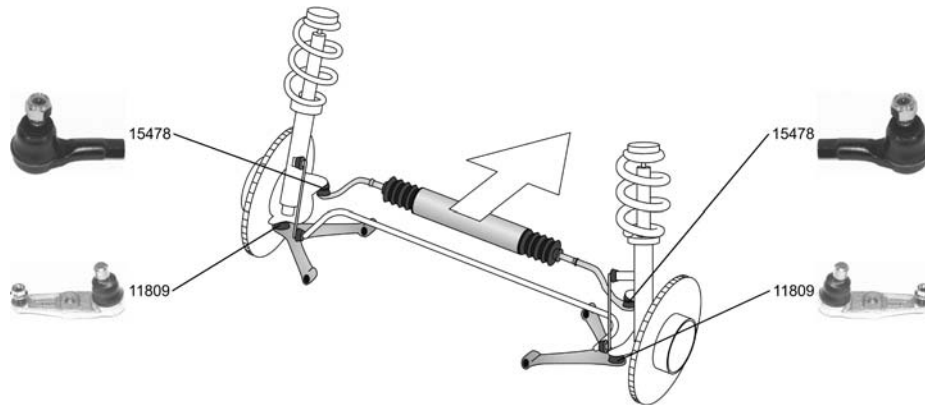

OE

MAZDA

323 S V (BA)

08.94 - 09.98







<p>Spurstangenkopf / Tie-rod End Gewindeart: mit Rechtsgewinde / Thread Type: with right-hand thread</p> <p>ALL TYPES ausser/except for : 1.6 09.94 - 05.98</p>		<p>15478 8AB2-32-280</p> 
<p>Trag-/Führungsgelenk / Support-/ Steering Link ohne Zubehör / without accessories</p> <p>1.3 16V 08.94 - 09.98 1.5 16V 08.94 - 09.98 1.8 16V 08.94 - 09.98 1.6 TD 02.95 - 09.98 2.0 D 10.96 - 09.98</p>	 Mot. RF, RF1G	<p>11809 B01A-34-550 A</p> 
<p>Stange/Strebe, Stabilisator / Rod/Strut, stabiliser Pendelstange / Suspension Rod</p> <p>ALL TYPES ausser/except for : 1.6 09.94 - 05.98</p>		<p>23039 GA2A-34-170 A</p> 
<p>Stange/Strebe, Stabilisator / Rod/Strut, stabiliser Pendelstange / Suspension Rod</p> <p>ALL TYPES ausser/except for : 1.6 09.94 - 05.98</p>		<p>24938 GA2A-34-150 A</p> 
<p>Faltenbalgsatz, Lenkung / Bellow Kit, steering system</p> <p>1.3 16V 08.94 - 09.98 1.5 16V 08.94 - 09.98</p>		<p>30231 NC10-32-125</p>

323 F VI (BJ)

09.98 -



<p>Stange/Strebe, Stabilisator / Rod/Strut, stabiliser Pendelstange / Suspension Rod</p> <p>1.4 16V 09.98 - 01.01 2.0 D 09.98 -</p>		<p>23039 GA2A-34-170 A</p> 
<p>Stange/Strebe, Stabilisator / Rod/Strut, stabiliser Pendelstange / Suspension Rod</p> <p>1.4 16V 09.98 - 01.01 2.0 D 09.98 -</p>		<p>24938 GA2A-34-150 A</p> 



MAZDA

323 F VI (BJ) 09.98 -

	Stange/Strebe, Stabilisator / Rod/Strut, stabiliser Pendelstange / Suspension Rod		↔	29658 B26R-34-170
	1.5 16V	09.98 - 01.01	Mot. ZL05,ZL06	
	1.9 16V	09.98 - 01.01	Mot. FP	
	2.0 D	09.98 -	Mot. RF1S	
	2.0 TD, 66 kW	09.98 - 01.01	Mot. RF3F	
	1.6, 72 kW	01.01 -	Mot. ZM39,ZM40	
	2.0	01.01 -		
	2.0 TD, 74 kW	01.01 -	Mot. RF2A,RF4F	
Faltenbalgsatz, Lenkung / Bellow Kit, steering system			↔	30231 NC10-32-125
	1.4 16V	09.98 - 01.01		
	1.5 16V	09.98 - 01.01		
	2.0 D	09.98 -		
	2.0 TD, 66 kW	09.98 - 01.01		

323 P VI (BJ) 09.98 -

	Faltenbalgsatz, Lenkung / Bellow Kit, steering system		↔	30231 NC10-32-125
	ALL TYPES			

323 S VI (BJ) 09.98 -

	Stange/Strebe, Stabilisator / Rod/Strut, stabiliser Pendelstange / Suspension Rod			23039 GA2A-34-170 A
	2.0 D	09.98 -	↻	
	Stange/Strebe, Stabilisator / Rod/Strut, stabiliser Pendelstange / Suspension Rod			24938 GA2A-34-150 A
	2.0 D	09.98 -	↻	
	Stange/Strebe, Stabilisator / Rod/Strut, stabiliser Pendelstange / Suspension Rod		↔	29658 B26R-34-170
	1.4 16V	09.98 - 01.01		
	2.0 TD	09.98 -		
	1.5 16V	09.98 - 01.01	Mot. ZL05,ZL06	
	1.9 16V	09.98 -	Mot. FP55	
	1.4	01.01 -	Mot. B35S	
	1.6, 72 kW	01.01 -	Mot. ZM39,ZM40	
Faltenbalgsatz, Lenkung / Bellow Kit, steering system			↔	30231 NC10-32-125
	1.4 16V	09.98 - 01.01		
	1.5 16V	09.98 - 01.01		
	2.0 D	09.98 -		
	2.0 TD	09.98 -		

626 II (GC) 11.82 - 09.87

	Spurstangenkopf / Tie-rod End Gewindeart: mit Rechtsgewinde / Thread Type: with right-hand thread Gewindemaß / Thread Size:M14x1,5		↔	11816 H001-99-324
	1.6	11.82 - 06.87		
	2.0, 74 kW	03.83 - 09.87		
	2.0, 88 kW	01.86 - 09.87		
	2.0 D	01.83 - 06.87		
	Axialgelenk, Spurstange / Axial Rod, tie rod Gewindemaß / Thread Size:M14x1,5 Gewindeart: mit Rechtsgewinde / Thread Type: with right-hand thread		↻ ↺	11811 G030-32-240 A
	1.6	11.82 - 06.87		
	2.0, 74 kW	03.83 - 09.87		
	2.0, 88 kW	01.86 - 09.87		
	2.0 D	01.83 - 06.87		

























OE

MAZDA

626 II (GC)

11.82 - 09.87

 Axialgelenk, Spurstange / Axial Rod, tie rod Gewindemaß / Thread Size:M14,5x1,5 Gewindeart: mit Rechtsgewinde / Thread Type: with right-hand thread		15497 G030-32-250 A 
	1.6 11.82 - 06.87 2.0, 74 kW 03.83 - 09.87 2.0, 88 kW 01.86 - 09.87 2.0 D 01.83 - 06.87	
Axialgelenk, Spurstange / Axial Rod, tie rod Gewindemaß / Thread Size:M14x1,5 Gewindeart: mit Rechtsgewinde / Thread Type: with right-hand thread		15499 G037-32-240 C 
	1.6 11.82 - 06.87 2.0, 74 kW 03.83 - 09.87 2.0, 88 kW 01.86 - 09.87 2.0 D 01.83 - 06.87	
Axialgelenk, Spurstange / Axial Rod, tie rod Gewindemaß / Thread Size:M14x1,5 Gewindeart: mit Rechtsgewinde / Thread Type: with right-hand thread		15500 G037-32-250 C 
	1.6 11.82 - 06.87 2.0, 74 kW 03.83 - 09.87 2.0, 88 kW 01.86 - 09.87 2.0 D 01.83 - 06.87	
Lenker, Radaufhängung / Track Control Arm		11812 G030-34-300 F 
	1.6 11.82 - 06.87 2.0, 74 kW 03.83 - 09.87 2.0, 88 kW 01.86 - 09.87 2.0 D 01.83 - 06.87	
Lenker, Radaufhängung / Track Control Arm		11813 G030-34-350 F 
	1.6 11.82 - 06.87 2.0, 74 kW 03.83 - 09.87 2.0, 88 kW 01.86 - 09.87 2.0 D 01.83 - 06.87	
Trag-/Führungsgelenk / Support-/ Steering Link		11814 G030-99-356 
	1.6 11.82 - 06.87 2.0, 74 kW 03.83 - 09.87 2.0, 88 kW 01.86 - 09.87 2.0 D 01.83 - 06.87	
Faltenbalgsatz, Lenkung / Bellow Kit, steering system		30141 H002-32-125 
	1.6 11.82 - 06.87 2.0, 74 kW 03.83 - 09.87 2.0, 88 kW 01.86 - 09.87 2.0 D 01.83 - 06.87	
Faltenbalgsatz, Lenkung / Bellow Kit, steering system		30165 G030-32-125 
	1.6 11.82 - 06.87 2.0, 74 kW 03.83 - 09.87 2.0, 88 kW 01.86 - 09.87 2.0 D 01.83 - 06.87	

626 II Hatchback/avec hayon (GC)

11.82 - 09.87

 Spurstangenkopf / Tie-rod End Gewindeart: mit Rechtsgewinde / Thread Type: with right-hand thread Gewindemaß / Thread Size:M14x1,5		11816 H001-99-324 
	ALL TYPES ausser/except for : 1.8 11.82 - 09.87	
Axialgelenk, Spurstange / Axial Rod, tie rod Gewindemaß / Thread Size:M14x1,5 Gewindeart: mit Rechtsgewinde / Thread Type: with right-hand thread		11811 G030-32-240 A 
	ALL TYPES ausser/except for : 1.8 11.82 - 09.87	



MAZDA

626 II Hatchback/avec hayon (GC)

11.82 - 09.87

<p> Axialgelenk, Spurstange / Axial Rod, tie rod Gewindemaß / Thread Size:M14,5x1,5 Gewindeart: mit Rechtsgewinde / Thread Type: with right-hand thread</p> <p>ALL TYPES ausser/except for : 1.8 11.82 - 09.87</p>	<p></p> <p></p>	<p>15497 G030-32-250 A</p> 
<p>Axialgelenk, Spurstange / Axial Rod, tie rod Gewindemaß / Thread Size:M14x1,5 Gewindeart: mit Rechtsgewinde / Thread Type: with right-hand thread</p> <p>ALL TYPES ausser/except for : 1.8 11.82 - 09.87</p>	<p></p> <p></p>	<p>15499 G037-32-240 C</p> 
<p>Axialgelenk, Spurstange / Axial Rod, tie rod Gewindemaß / Thread Size:M14x1,5 Gewindeart: mit Rechtsgewinde / Thread Type: with right-hand thread</p> <p>ALL TYPES ausser/except for : 1.8 11.82 - 09.87</p>	<p></p> <p></p>	<p>15500 G037-32-250 C</p> 
<p>Lenker, Radaufhängung / Track Control Arm</p> <p>ALL TYPES ausser/except for : 1.8 11.82 - 09.87</p>	<p></p>	<p>11812 G030-34-300 F</p> 
<p>Lenker, Radaufhängung / Track Control Arm</p> <p>ALL TYPES ausser/except for : 1.8 11.82 - 09.87</p>	<p></p>	<p>11813 G030-34-350 F</p> 
<p>Trag-/Führungsgelenk / Support-/ Steering Link</p> <p>ALL TYPES ausser/except for : 1.8 11.82 - 09.87</p>	<p></p>	<p>11814 G030-99-356</p> 
<p>Faltenbalgsatz, Lenkung / Bellow Kit, steering system</p> <p>ALL TYPES ausser/except for : 1.8 11.82 - 09.87</p>	<p></p> <p></p>	<p>30141 H002-32-125</p> 
<p>Faltenbalgsatz, Lenkung / Bellow Kit, steering system</p> <p>ALL TYPES ausser/except for : 1.8 11.82 - 09.87</p>	<p></p>	<p>30165 G030-32-125</p> 



MAZDA

626 III Coupe (GD)

06.87 - 05.92

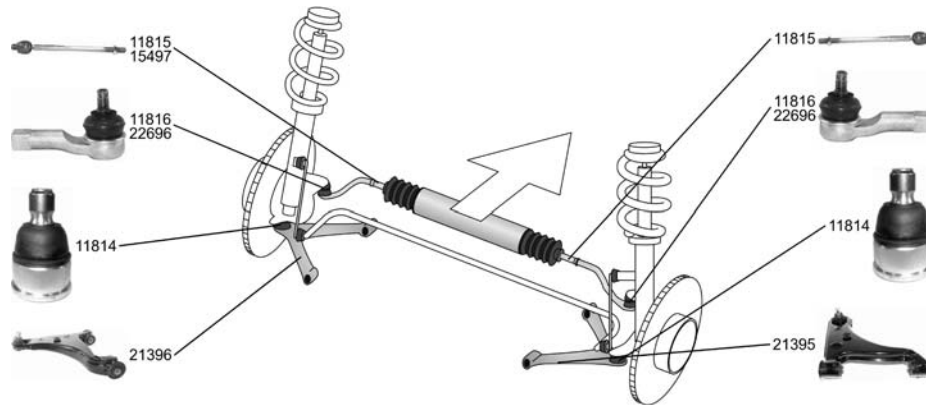

<p>Spurstangenkopf / Tie-rod End Gewindeart: mit Rechtsgewinde / Thread Type: with right-hand thread Gewindemaß / Thread Size: M14x1,5 ALL TYPES ausser/except for : 1.6 06.87 - 05.92</p>	<p>↔</p> <p>->Chass. 561648</p>	<p>11816 H001-99-324</p> 
<p>Spurstangenkopf / Tie-rod End ALL TYPES ausser/except for : 1.6 06.87 - 05.92</p>	<p>↔ ♂</p> <p>Chass. 561649-></p>	<p>22696 8AG4-32-280</p> 
<p>Axialgelenk, Spurstange / Axial Rod, tie rod ALL TYPES ausser/except for : 1.6 06.87 - 05.92</p>	<p>↔ ↗</p>	<p>11815 GJ22-32-240</p> 
<p>Axialgelenk, Spurstange / Axial Rod, tie rod Gewindemaß / Thread Size: M14,5x1,5 Gewindeart: mit Rechtsgewinde / Thread Type: with right-hand thread ALL TYPES ausser/except for : 1.6 06.87 - 05.92</p>	<p>↗ ↗</p> <p>⊘</p>	<p>15497 G030-32-250 A</p> 
<p>Lenker, Radaufhängung / Track Control Arm ALL TYPES ausser/except for : 1.6 06.87 - 05.92</p>	<p>▽ ↻</p>	<p>21395 GJ22-34-300B</p> 
<p>Lenker, Radaufhängung / Track Control Arm ALL TYPES ausser/except for : 1.6 06.87 - 05.92</p>	<p>▽ ↻</p>	<p>21396 GJ22-34-350B</p> 
<p>Trag-/Führungsgelenk / Support-/ Steering Link ALL TYPES ausser/except for : 1.6 06.87 - 05.92</p>	<p>▽ ↻ ♂</p>	<p>11814 G030-99-356</p> 





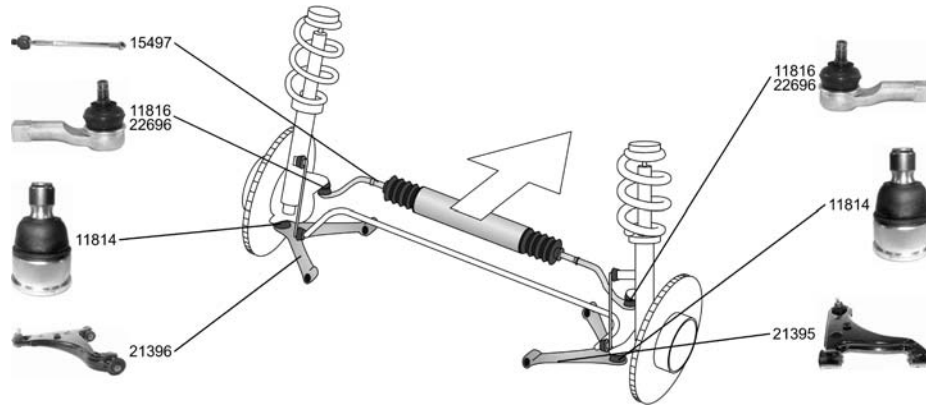

MAZDA

626 III Station Wagon/Estate/Break (GV)

09.87 - 11.96



Spurstangenkopf / Tie-rod End Gewindeart: mit Rechtsgewinde / Thread Type: with right-hand thread Gewindemaß / Thread Size:M14x1,5		↔	11816 H001-99-324		
1.8	01.88 - 03.92	->Chass. 205496			
2.0	10.88 - 09.97				
2.0 12V	09.87 - 01.90				
2.0 16V	01.88 - 03.92				
2.2 12V	03.89 - 11.96				
2.2 12V 4WD	05.91 - 11.92				
2.0 i	11.94 - 09.97				
2.0 D, 60 kW	11.94 - 09.97				
2.0 D Complex	05.93 - 11.96				
2.0 D, 44 kW	09.88 - 07.91			->Chass. 561648	
Spurstangenkopf / Tie-rod End		↔ ↻	22696 8AG4-32-280		
1.8	01.88 - 03.92	Chass. 205497->			
2.0	10.88 - 09.97				
2.0 12V	09.87 - 01.90				
2.0 16V	01.88 - 03.92				
2.2 12V	03.89 - 11.96				
2.2 12V 4WD	05.91 - 11.92				
2.0 D, 44 kW	09.88 - 07.91				
2.0 D Complex	05.93 - 11.96				
Axialgelenk, Spurstange / Axial Rod, tie rod Gewindemaß / Thread Size:M14,5x1,5 Gewindeart: mit Rechtsgewinde / Thread Type: with right-hand thread				↻ ↻	15497 G030-32-250 A
1.8	01.88 - 03.92				
2.0	10.88 - 09.97				
2.0 12V	09.87 - 01.90				
2.0 16V	01.88 - 03.92				
2.2 12V	03.89 - 11.96				
2.2 12V 4WD	05.91 - 11.92				
2.0 D, 44 kW	09.88 - 07.91				
2.0 D Complex	05.93 - 11.96				
Lenker, Radaufhängung / Track Control Arm		▽ ↻	21395 GJ22-34-300B		
1.8	01.88 - 03.92				
2.0	10.88 - 09.97				
2.0 12V	09.87 - 01.90				
2.0 16V	01.88 - 03.92				
2.2 12V	03.89 - 11.96				
2.0 D, 44 kW	09.88 - 07.91				
Lenker, Radaufhängung / Track Control Arm			▽ ↻	21396 GJ22-34-350B	
1.8	01.88 - 03.92				
2.0	10.88 - 09.97				
2.0 12V	09.87 - 01.90				
2.0 16V	01.88 - 03.92				
2.2 12V	03.89 - 11.96				
2.0 D, 44 kW	09.88 - 07.91				





OE

MAZDA

626 III Station Wagon/Estate/Break (GV)







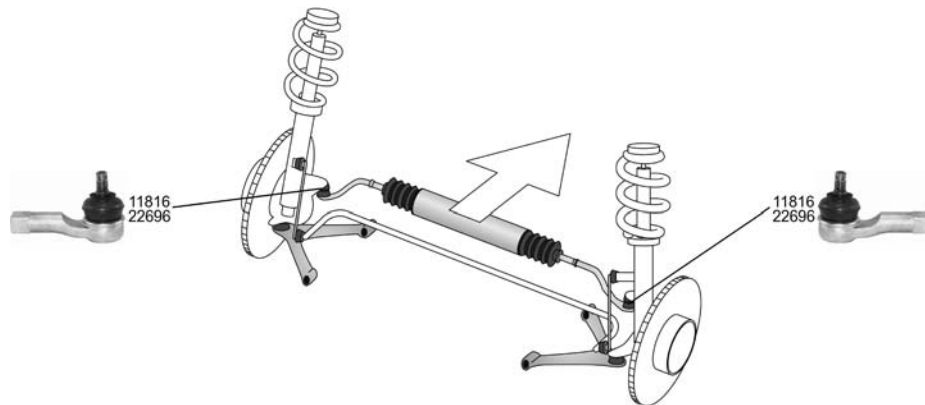

09.87 - 11.96

 Trag-/Führungsgelenk / Support-/ Steering Link			11814	G030-99-356
1.8	01.88 - 03.92			
2.0	10.88 - 09.97			
2.0 12V	09.87 - 01.90			
2.0 16V	01.88 - 03.92			
2.2 12V	03.89 - 11.96			
2.2 12V 4WD	05.91 - 11.92			
2.0 D, 44 kW	09.88 - 07.91			
2.0 D Complex	05.93 - 11.96			

626 IV (GE)

08.91 - 04.97



Spurstangenkopf / Tie-rod End Gewindeart: mit Rechtsgewinde / Thread Type: with right-hand thread Gewindemaß / Thread Size: M14x1,5		11816	H001-99-324
ALL TYPES ausser/except for : 2.5	09.91 - 12.97		
Spurstangenkopf / Tie-rod End		22696	8AG4-32-280
1.8 i	01.92 - 04.97		
2.0 i	01.92 - 04.97		
2.0 D GLX Complex	10.92 - 04.97		
Stange/Strebe, Stabilisator / Rod/Strut, stabiliser Pendelstange / Suspension Rod		23039	GA2A-34-170 A
ALL TYPES ausser/except for : 2.5	09.91 - 12.97		
Stange/Strebe, Stabilisator / Rod/Strut, stabiliser Pendelstange / Suspension Rod		24938	GA2A-34-150 A
ALL TYPES ausser/except for : 2.5	09.91 - 12.97		
 Stange/Strebe, Stabilisator / Rod/Strut, stabiliser Pendelstange / Suspension Rod		22698	GA2C-28-170B
1.8 i	01.92 - 04.97		
2.0 i	01.92 - 04.97		
2.0 D GLX Complex	10.92 - 04.97		









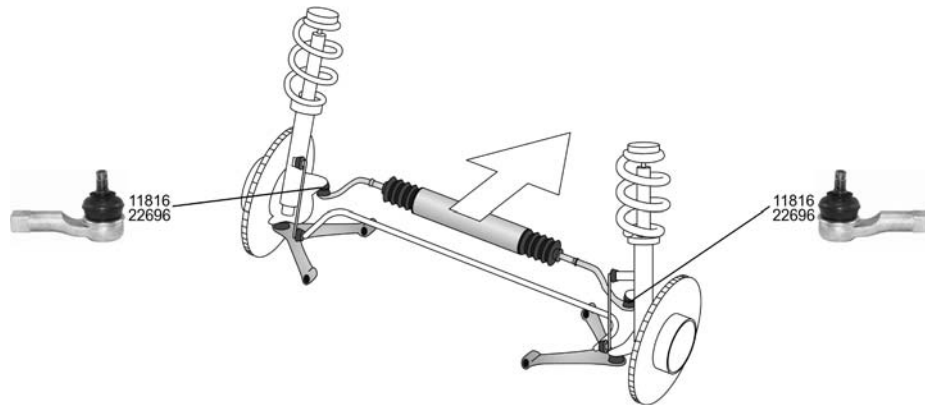



MAZDA

626 IV Hatchback/avec hayon (GE)





08.91 - 04.97



<p>Spurstangenkopf / Tie-rod End Gewindeart: mit Rechtsgewinde / Thread Type: with right-hand thread Gewindemaß / Thread Size:M14x1,5</p>		<p>11816 H001-99-324</p>
<p>ALL TYPES</p>		
<p>Spurstangenkopf / Tie-rod End</p>		<p>22696 8AG4-32-280</p>
<p>ALL TYPES ausser/except for : 2.0 i 4WD 04.92 - 04.97</p>		
<p>Stange/Strebe, Stabilisator / Rod/Strut, stabiliser Pendelstange / Suspension Rod</p>		<p>23039 GA2A-34-170 A</p>
<p>ALL TYPES</p>		
<p>Stange/Strebe, Stabilisator / Rod/Strut, stabiliser Pendelstange / Suspension Rod</p>		<p>24938 GA2A-34-150 A</p>
<p>ALL TYPES</p>		
<p> Stange/Strebe, Stabilisator / Rod/Strut, stabiliser Pendelstange / Suspension Rod</p>		<p>22698 GA2C-28-170B</p>
<p>ALL TYPES ausser/except for : 2.0 i 4WD 04.92 - 04.97</p>		

626 V (GF)

05.97 -





<p> Stange/Strebe, Stabilisator / Rod/Strut, stabiliser Pendelstange / Suspension Rod</p>		<p>23039 GA2A-34-170 A</p>
<p>ALL TYPES ausser/except for : 1.9, 66 kW 05.97 - 12.99</p>		
<p>Stange/Strebe, Stabilisator / Rod/Strut, stabiliser Pendelstange / Suspension Rod</p>		<p>24938 GA2A-34-150 A</p>
<p>ALL TYPES ausser/except for : 1.9, 66 kW 05.97 - 12.99</p>		







OE

MAZDA







626 V Hatchback/avec hayon (GF) 05.97 -

 Stange/Strebe, Stabilisator / Rod/Strut, stabiliser Pendelstange / Suspension Rod ALL TYPES ausser/except for : 1.8 05.97 - 12.99		23039 GA2A-34-170 A 
		24938 GA2A-34-150 A 







626 V Station Wagon/Estate/Break (GW) 02.98 -

 Stange/Strebe, Stabilisator / Rod/Strut, stabiliser Pendelstange / Suspension Rod ALL TYPES		23039 GA2A-34-170 A 
		24938 GA2A-34-150 A 

929 II (HB) 12.81 - 09.87

 Spurstangenkopf / Tie-rod End Gewindart: mit Rechtsgewinde / Thread Type: with right-hand thread Gewindemaß / Thread Size:M14x1,5 ALL TYPES		11816 H001-99-324 
		11817 H001-99-356 
Trag-/Führungsgelenk / Support-/ Steering Link Konusmaß [mm] / Cone Size [mm]:16 ALL TYPES		11817 H001-99-356 

929 II Coupe (HB) 12.81 - 09.87

 Spurstangenkopf / Tie-rod End Gewindart: mit Rechtsgewinde / Thread Type: with right-hand thread Gewindemaß / Thread Size:M14x1,5 ALL TYPES		11816 H001-99-324 
		11817 H001-99-356 
Trag-/Führungsgelenk / Support-/ Steering Link Konusmaß [mm] / Cone Size [mm]:16 ALL TYPES		11817 H001-99-356 





OE

MAZDA

929 II Station Wagon (HV)









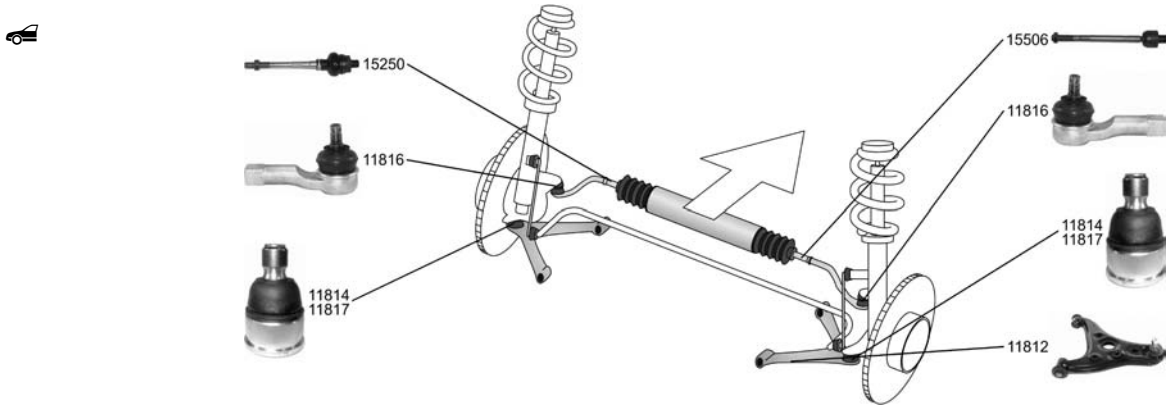



01.83 - 12.87

<p> Spurstangenkopf / Tie-rod End Gewindeart: mit Rechtsgewinde / Thread Type: with right-hand thread Gewindemaß / Thread Size: M14x1,5 ALL TYPES</p>		<p>11816 H001-99-324</p> 
--	---	---

929 III (HC)

05.87 - 06.91



<p>Spurstangenkopf / Tie-rod End Gewindeart: mit Rechtsgewinde / Thread Type: with right-hand thread Gewindemaß / Thread Size: M14x1,5 ALL TYPES</p>		<p>11816 H001-99-324</p> 
<p>Axialgelenk, Spurstange / Axial Rod, tie rod ALL TYPES</p>		<p>15250 H260-32-240 A</p> 
<p>Axialgelenk, Spurstange / Axial Rod, tie rod Gewindemaß / Thread Size: M14x1,5 Gewindeart: mit Rechtsgewinde / Thread Type: with right-hand thread ALL TYPES</p>		<p>15506 H261-32-240 A</p> 
<p>Lenker, Radaufhängung / Track Control Arm ALL TYPES</p>		<p>11812 G030-34-300 F</p> 
<p>Trag-/Führungsgelenk / Support-/ Steering Link ALL TYPES</p>		<p>11814 G030-99-356</p> 
<p>Trag-/Führungsgelenk / Support-/ Steering Link Konusmaß [mm] / Cone Size [mm]: 16 ALL TYPES</p>		<p>11817 H001-99-356</p> 







OE

MAZDA

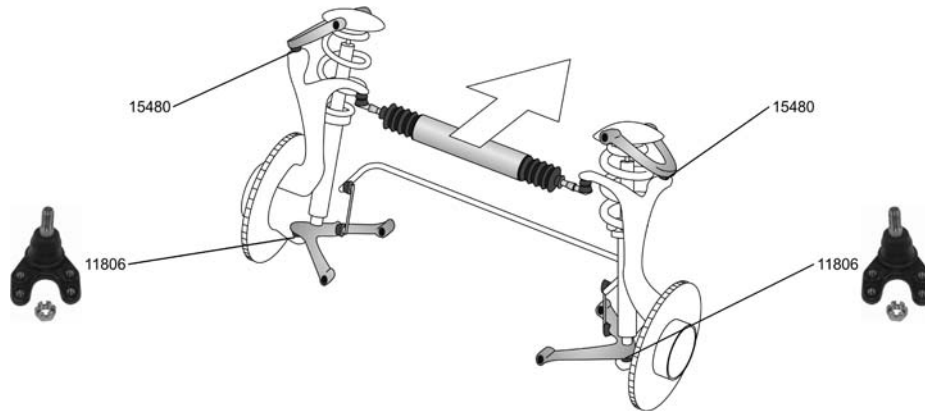
B-SERIE (UF)









01.85 - 06.99



Trag-/Führungsgelenk / Support-/ Steering Link		11806 8AU2-34-510
2.2	08.91 - 12.96	
2.6 12V 4WD	01.90 - 06.99	
2.5 D 4WD, 57 kW	09.98 - 06.99	
2.5 D	02.96 - 06.99	
2.5 D 4WD, 63 kW	02.96 - 06.99	
Trag-/Führungsgelenk / Support-/ Steering Link		15480 8AU1-34-540
2.2	08.91 - 12.96	
2.6 12V 4WD	01.90 - 06.99	
2.5 D 4WD, 57 kW	09.98 - 06.99	
2.5 D	02.96 - 06.99	
2.5 D 4WD, 63 kW	02.96 - 06.99	

E 2000,2200 Bus/Familial (SR1)

01.84 - 05.94

 Spurstangenkopf / Tie-rod End Gewindeart: mit Rechtsgewinde / Thread Type: with right-hand thread Gewindemaß / Thread Size: M14x1,5		14914 S083-99-324
2.0, 63 kW	11.84 - 02.88	
2.2 D, 46 kW	01.84 - 02.88	
Axialgelenk, Spurstange / Axial Rod, tie rod Gewindeart: mit Rechtsgewinde / Thread Type: with right-hand thread Gewindemaß / Thread Size: M14x1,5		15248 S083-32-115
2.0, 63 kW	11.84 - 02.88	
2.0 4WD	10.88 - 09.89	
2.2 D, 46 kW	01.84 - 02.88	
Trag-/Führungsgelenk / Support-/ Steering Link Konusmaß [mm] / Cone Size [mm]: 17,8		14915 S083-99-354
2.0, 63 kW	11.84 - 02.88	
2.0 4WD	10.88 - 09.89	
2.2 D, 46 kW	01.84 - 02.88	
Trag-/Führungsgelenk / Support-/ Steering Link		14916 S083-99-356
2.0, 63 kW	11.84 - 02.88	
2.0 4WD	10.88 - 09.89	
2.2 D, 46 kW	01.84 - 02.88	









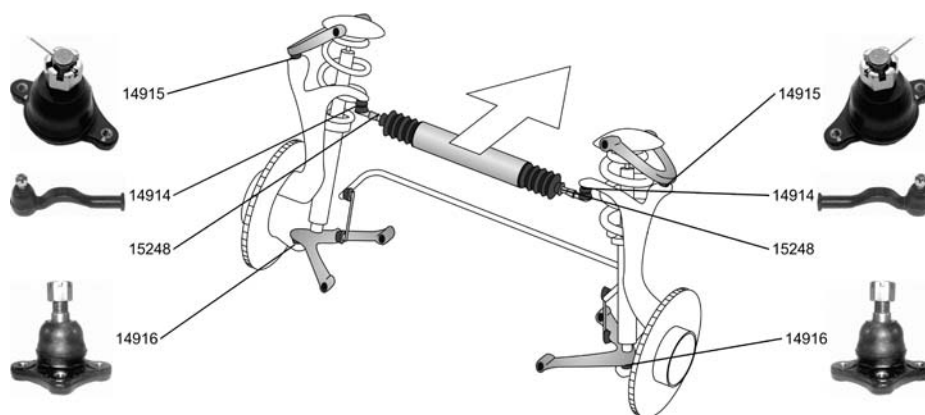

MAZDA

E 2000,2200

01.84 -

Kasten/Box/Furgón/Van (SR2)





<p>Spurstangenkopf / Tie-rod End Gewindeart: mit Rechtsgewinde / Thread Type: with right-hand thread Gewindemaß / Thread Size:M14x1,5</p> <p>2.0 05.85 - 05.94 2.2 D 05.85 - 08.02</p>		<p>14914 S083-99-324</p> 
<p>Axialgelenk, Spurstange / Axial Rod, tie rod Gewindeart: mit Rechtsgewinde / Thread Type: with right-hand thread Gewindemaß / Thread Size:M14x1,5</p> <p>2.0 05.85 - 05.94 2.2 D, 46 kW 05.85 - 02.88 2.2 D, 47 kW 03.91 - 2.2 D 4WD, 47 kW 03.91 -</p>		<p>15248 S083-32-115</p>
<p>Trag-/Führungsgelenk / Support-/ Steering Link Konusmaß [mm] / Cone Size [mm]:17,8</p> <p>2.0 05.85 - 05.94 2.2 D, 46 kW 05.85 - 02.88 2.2 D, 47 kW 03.91 - 2.2 D 4WD, 47 kW 03.91 -</p>		<p>14915 S083-99-354</p> 
<p>Trag-/Führungsgelenk / Support-/ Steering Link</p> <p>2.0 05.85 - 05.94 2.2 D 05.85 - 08.02</p>		<p>14916 S083-99-356</p> 

MX-3 (EC)

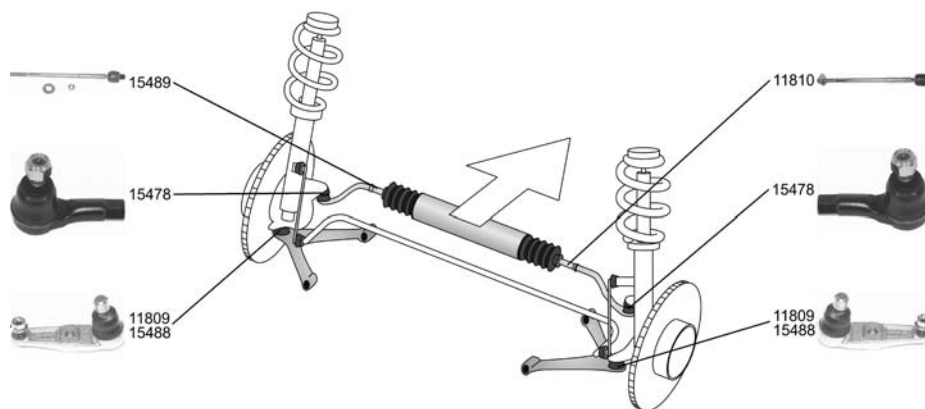
07.91 -



<p>Spurstangenkopf / Tie-rod End Gewindeart: mit Rechtsgewinde / Thread Type: with right-hand thread ALL TYPES</p>		<p>15478 8AB2-32-280</p> 
---	---	--















OE

MAZDA



MX-3 (EC)

07.91 -

	Axialgelenk, Spurstange / Axial Rod, tie rod Gewindemaß / Thread Size:M12x1,25 Gewindeart: mit Rechtsgewinde / Thread Type: with right-hand thread		11810	B456-32-24X	
	ALL TYPES				
	Axialgelenk, Spurstange / Axial Rod, tie rod Gewindemaß / Thread Size:M12x1,25 Gewindeart: mit Rechtsgewinde / Thread Type: with right-hand thread		15489	B456-32-25X	
	ALL TYPES				
	Trag-/Führungsgelenk / Support-/ Steering Link ohne Zubehör / without accessories		11809	B01A-34-550 A	
	ALL TYPES				
	Trag-/Führungsgelenk / Support-/ Steering Link		15488	B455-34-550	
	ALL TYPES				









MX-5 I (NA)

09.89 - 04.98

	Faltenbalgsatz, Lenkung / Bellow Kit, steering system		30231	NC10-32-125	
	ALL TYPES				

MX-5 II (NB)

05.98 -

	Faltenbalgsatz, Lenkung / Bellow Kit, steering system		30231	NC10-32-125	
	1.6 16V 1.8 16V	05.98 - 05.98 -			
	Stange/Strebe, Stabilisator / Rod/Strut, stabiliser Pendelstange / Suspension Rod		23039	GA2A-34-170 A	
	ALL TYPES				
	Stange/Strebe, Stabilisator / Rod/Strut, stabiliser Pendelstange / Suspension Rod		24938	GA2A-34-150 A	
	ALL TYPES				





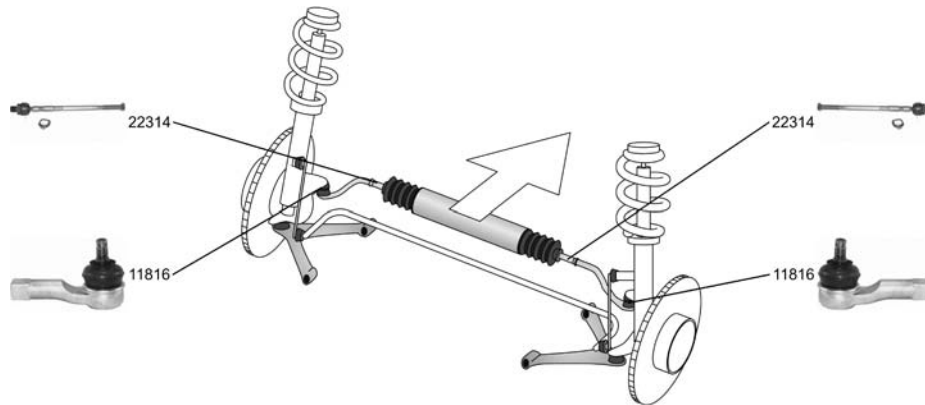

MAZDA

MX-6 (GE6)

07.91 -



<p>Spurstangenkopf / Tie-rod End Gewindeart: mit Rechtsgewinde / Thread Type: with right-hand thread Gewindemaß / Thread Size:M14x1,5</p> <p>2.0 02.92 - 2.5 i 24V 08.94 - 2.5 24V 02.92 -</p>	↔	<p>11816 H001-99-324</p> 
<p>Axialgelenk, Spurstange / Axial Rod, tie rod</p> <p>2.0 02.92 - 2.5 i 24V 08.94 - 2.5 24V 02.92 -</p>	↔	<p>22314 3 405 940 GA2A-32-240</p> 
<p>Stange/Strebe, Stabilisator / Rod/Strut, stabiliser Pendelstange / Suspension Rod</p> <p>2.0 02.92 - 2.5 i 24V 08.94 - 2.5 24V 02.92 -</p>	↻	<p>23039 GA2A-34-170 A</p> 
<p>Stange/Strebe, Stabilisator / Rod/Strut, stabiliser Pendelstange / Suspension Rod</p> <p>2.0 02.92 - 2.5 i 24V 08.94 - 2.5 24V 02.92 -</p>	↻	<p>24938 GA2A-34-150 A</p> 

PREMACY (CP)

07.99 -



<p>Faltenbalgsatz, Lenkung / Bellow Kit, steering system ALL TYPES</p>	↔	<p>30239 BJ25-32-125</p>
--	---	---------------------------------





OE

MAZDA

RX 7 III (FD)

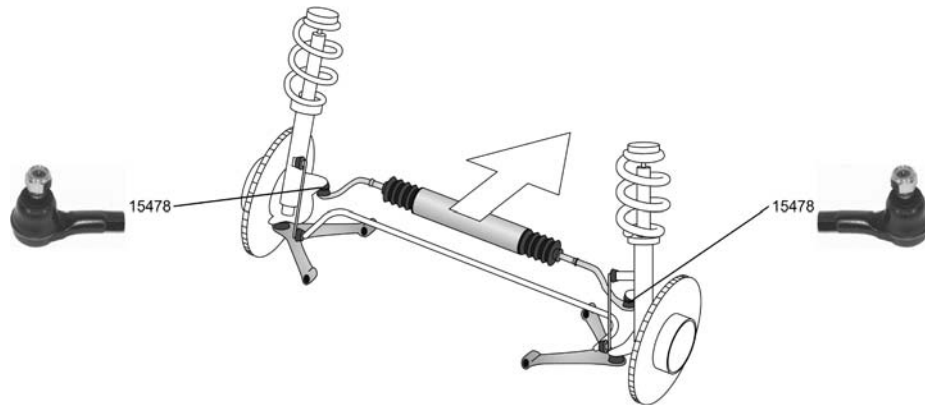
07.92 -







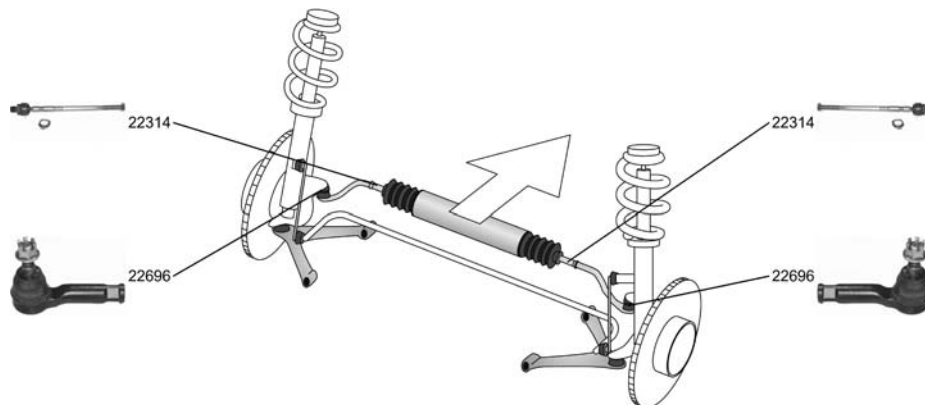

Spurstangenkopf / Tie-rod End Gewindeart: mit Rechtsgewinde / Thread Type: with right-hand thread ALL TYPES		15478 8AB2-32-280
		

XEDOS 6 (CA)

01.92 -



Spurstangenkopf / Tie-rod End ALL TYPES		22696 8AG4-32-280
		
Axialgelenk, Spurstange / Axial Rod, tie rod ALL TYPES		22314 3 405 940 GA2A-32-240
		
Stange/Strebe, Stabilisator / Rod/Strut, stabiliser Pendelstange / Suspension Rod ALL TYPES		23039 GA2A-34-170 A
		
Stange/Strebe, Stabilisator / Rod/Strut, stabiliser Pendelstange / Suspension Rod ALL TYPES		24938 GA2A-34-150 A
		



MAZDA

Arithmetische Liste / Part number list

Artikelnummer Article No.	Seite Page	Hersteller Manufacturer	Artikelnummer Article No.	Seite Page	Hersteller Manufacturer
11804	4	MAZDA	15250	26	MAZDA
Trag-/Führungsgelenk / Support-/ Steering Link			Axialgelenk, Spurstange / Axial Rod, tie rod		
11805	3 5 6	MAZDA	15252	9 10 11	MAZDA
Spurstangenkopf / Tie-rod End	8		Axialgelenk, Spurstange / Axial Rod, tie rod		
11806	27	MAZDA	15478	3 9 10	MAZDA
Trag-/Führungsgelenk / Support-/ Steering Link			Spurstangenkopf / Tie-rod End	11 12 13 14 15 28	
11807	5 6 7	MAZDA	15480	27	MAZDA
Trag-/Führungsgelenk / Support-/ Steering Link	8		Trag-/Führungsgelenk / Support-/ Steering Link		
11808	5 7 8	MAZDA	15483	6 7 8	MAZDA
Spurstangenkopf / Tie-rod End			Axialgelenk, Spurstange / Axial Rod, tie rod		
11809	6 9 10	MAZDA	15488	9 11 12	MAZDA
Trag-/Führungsgelenk / Support-/ Steering Link	11 12 13 14 15 29		Trag-/Führungsgelenk / Support-/ Steering Link	29	
11810	9 10 11	MAZDA	15489	9 10 11	MAZDA
Axialgelenk, Spurstange / Axial Rod, tie rod	29		Axialgelenk, Spurstange / Axial Rod, tie rod	29	
11811	16 17	MAZDA	15497	17 18 19	MAZDA
Axialgelenk, Spurstange / Axial Rod, tie rod			Axialgelenk, Spurstange / Axial Rod, tie rod	20 21 22	
11812	17 18 26	MAZDA	15499	17 18	MAZDA
Lenker, Radaufhängung / Track Control Arm			Axialgelenk, Spurstange / Axial Rod, tie rod		
11813	17 18	MAZDA	15500	17 18	MAZDA
Lenker, Radaufhängung / Track Control Arm			Axialgelenk, Spurstange / Axial Rod, tie rod		
11814	17 18 19	MAZDA	15506	26	MAZDA
Trag-/Führungsgelenk / Support-/ Steering Link	20 21 23 26		Axialgelenk, Spurstange / Axial Rod, tie rod		
11815	19 20 21	MAZDA	17786	4	MAZDA
Axialgelenk, Spurstange / Axial Rod, tie rod			Trag-/Führungsgelenk / Support-/ Steering Link		
11816	16 17 19	MAZDA	17795	4	MAZDA
Spurstangenkopf / Tie-rod End	20 21 22 23 24 25 26 30		Spurstangenkopf / Tie-rod End		
11817	25 26	MAZDA	17796	4	MAZDA
Trag-/Führungsgelenk / Support-/ Steering Link			Spurstangenkopf / Tie-rod End		
14914	27 28	MAZDA	21395	19 20 21 22	MAZDA
Spurstangenkopf / Tie-rod End			Lenker, Radaufhängung / Track Control Arm		
14915	27 28	MAZDA	21396	19 20 21 22	MAZDA
Trag-/Führungsgelenk / Support-/ Steering Link			Lenker, Radaufhängung / Track Control Arm		
14916	27 28	MAZDA	22314	30 31	MAZDA
Trag-/Führungsgelenk / Support-/ Steering Link			Axialgelenk, Spurstange / Axial Rod, tie rod		
15248	27 28	MAZDA	22696	19 20 21 22 23 24	MAZDA
Axialgelenk, Spurstange / Axial Rod, tie rod			Spurstangenkopf / Tie-rod End		

Artikelnummer Article No.	Seite Page	Hersteller Manufacturer	Artikelnummer Article No.	Seite Page	Hersteller Manufacturer
22698 ⊕	23 24	MAZDA	30247 ⊕	2	MAZDA
Stange/Strebe, Stabilisator / Rod/Strut, stabiliser			Faltenbalgsatz, Lenkung / Bellow Kit, steering system		
23039	9 12 13 14 15 16 23 24 25 29 30 31	MAZDA	30360 ▽⊕	3	MAZDA
Stange/Strebe, Stabilisator / Rod/Strut, stabiliser			Lenker, Radaufhängung / Track Control Arm		
24938	10 12 13 14 15 16 23 24 25 29 30 31	MAZDA			
Stange/Strebe, Stabilisator / Rod/Strut, stabiliser					
26000 ⊕♂	1	MAZDA			
Spurstangenkopf / Tie-rod End					
26001 ⊕♂	1	MAZDA			
Spurstangenkopf / Tie-rod End					
26002 ⊕♂	1	MAZDA			
Axialgelenk, Spurstange / Axial Rod, tie rod					
26003 ▽⊕	1	MAZDA			
Trag-/Führungsgelenk / Support-/ Steering Link					
26004 ⊕	1	MAZDA			
Stange/Strebe, Stabilisator / Rod/Strut, stabiliser					
27308 ▽⊕Ⓛ	4	MAZDA			
Lagerung, Lenker / Mounting, wishbone					
27408 Ⓛ♂	4	MAZDA			
Lagerung, Lenker / Mounting, wishbone					
28968 ⊕△	4	MAZDA			
Axialgelenk, Spurstange / Axial Rod, tie rod					
29499 ⊕	1 2	MAZDA			
Stange/Strebe, Stabilisator / Rod/Strut, stabiliser					
29658 ⊕	6 10 11 12 16	MAZDA			
Stange/Strebe, Stabilisator / Rod/Strut, stabiliser					
30141 ⊕	6 7 8 17 18	MAZDA			
Faltenbalgsatz, Lenkung / Bellow Kit, steering system					
30165 Ⓢ⊕	17 18	MAZDA			
Faltenbalgsatz, Lenkung / Bellow Kit, steering system					
30193 ⊕	3	MAZDA			
Faltenbalgsatz, Lenkung / Bellow Kit, steering system					
30231 ⊕	13 14 15 16 29	MAZDA			
Faltenbalgsatz, Lenkung / Bellow Kit, steering system					
30239 ⊕	12 13 14 30	MAZDA			
Faltenbalgsatz, Lenkung / Bellow Kit, steering system					

Vergleichsliste / Cross reference list

Vergleichs-Nr. Compare No.	Artikelnummer Article No.	Vergleichs-Nr. Compare No.	Artikelnummer Article No.	Vergleichs-Nr. Compare No.	Artikelnummer Article No.
MAZDA					
1E00 32 240	28968				
1E00-32-280 A	17796				
1E00-34-153A	27408				
1E01-32-280 A	17795				
1E01-34-153A	27308				
3 405 940	22314				
8531-99-356	11804				
8AB1-32-280	11805				
8AB2-32-280	15478				
8AG4-32-280	22696				
8AU1-34-540	15480				
8AU2-34-510	11806				
B001-99-325	11808				
B01A-34-550 A	11809				
B092-34-550	11807				
B094-32-240	15483				
B26R-34-170	29658				
B455-32-24X	15252				
B455-34-550	15488				
B456-32-24X	11810				
B456-32-25X	15489				
BJ25-32-125	30239				
BP4K-34-170C	29499				
DD32-34-170	26004				
DE90-32-240	26002				
DE90-32-280	26001				
DE90-32-290	26000				
G030-32-125	30165				
G030-32-240 A	11811				
G030-32-250 A	15497				
G030-34-300 F	11812				
G030-34-350 F	11813				
G030-99-356	11814				
G037-32-240 C	15499				
G037-32-250 C	15500				
GA2A-32-240	22314				
GA2A-34-150 A	24938				
GA2A-34-170 A	23039				
GA2C-28-170B	22698				
GJ22-32-240	11815				
GJ22-34-300B	21395				
GJ22-34-350B	21396				
H001-99-324	11816				
H001-99-356	11817				
H002-32-125	30141				
H260-32-240 A	15250				
H261-32-240 A	15506				
NC10-32-125	30231				
S083-32-115	15248				
S083-99-324	14914				
S083-99-354	14915				
S083-99-356	14916				
S47P32125	30247				

Neuaufnahmen / New to range

Artikelnummer Article No.	Seite Page	Hersteller Manufacturer
11806	27	MAZDA
11809	6 9 10 11 12 13 14 15 29	MAZDA
11814	17 18 19 20 21 23 26	MAZDA
11815	19 20 21	MAZDA
14914	27 28	MAZDA
14916	27 28	MAZDA
15248	27 28	MAZDA
15480	27	MAZDA
17786	4	MAZDA
21395	19 20 21 22	MAZDA
21396	19 20 21 22	MAZDA
22696	19 20 21 22 23 24 31	MAZDA
22698	23 24	MAZDA
23039	9 12 13 14 15 16 23 24 25 29 30 31	MAZDA
24938	10 12 13 14 15 16 23 24 25 29 30 31	MAZDA
26000	1	MAZDA
26001	1	MAZDA
26002	1	MAZDA
26003	1	MAZDA
26004	1	MAZDA
27308	4	MAZDA
27408	4	MAZDA
28968	4	MAZDA
29499	1 2	MAZDA
29658	6 10 11 12 16	MAZDA
30141	6 7 8 17 18	MAZDA
30165	17 18	MAZDA
30193	3	MAZDA
30231	13 14 15 16 29	MAZDA
30239	12 13 14 30	MAZDA
30247	2	MAZDA
30360	3	MAZDA

Artikelnummer Article No.	Seite Page	Hersteller Manufacturer
------------------------------	---------------	----------------------------

Geänderte Bestellnummer / Amended part numbers

Artikelnummer alt Article No. old	Artikelnummer neu Article No. new	Artikelnummer alt Article No. old	Artikelnummer neu Article No. new	Artikelnummer alt Article No. old	Artikelnummer neu Article No. new
15504	30141				
19195	30165				
28038	28968				

Geänderte Bestellnummer / Amended part numbers

Artikelnummer neu Article No. new	Artikelnummer alt Article No. old	Artikelnummer neu Article No. new	Artikelnummer alt Article No. old	Artikelnummer neu Article No. new	Artikelnummer alt Article No. old
28968	28038				
30141	15504				
30165	19195				

© ZF Trading GmbH - 14.10.06